

TVSS5

THREE-PHASE ELECTRONIC FAN SPEED CONTROLLER

Mounting and operating instructions

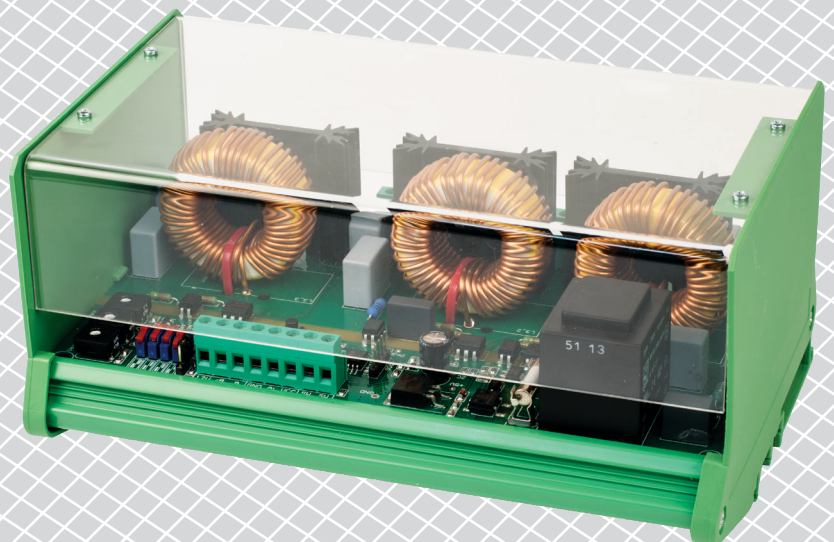

Table of contents

SAFETY AND PRECAUTIONS	3
PRODUCT DESCRIPTION	4
ARTICLE CODES	4
INTENDED AREA OF USE	4
TECHNICAL DATA	4
STANDARDS	4
WIRING AND CONNECTIONS	5
OPERATIONAL DIAGRAMS	5
MOUNTING INSTRUCTIONS IN STEPS	5
VERIFICATION OF INSTALLATION INSTRUCTIONS	8
OPERATING INSTRUCTIONS	9
TRANSPORT AND STORAGE	10
WARRANTY AND RESTRICTIONS	10
MAINTENANCE	10

SAFETY AND PRECAUTIONS



Read all the information, the datasheet, Modbus register maps, mounting and operating instructions and study the wiring and connection diagram before working with the product. For personal and equipment safety, and for optimum product performance, make sure you entirely understand the contents before installing, using, or maintaining this product.



For safety and licensing (CE) reasons, unauthorised conversion and /or modifications of the product are inadmissible.



The product should not be exposed to abnormal conditions, such as: extreme temperatures, direct sunlight or vibrations. Long-term exposure to chemical vapours in high concentration can affect the product performance. Make sure the work environment is as dry as possible; avoid condensation.



All installations shall comply with local health and safety regulations and local electrical standards and approved codes. This product can only be installed by an engineer or a technician who has expert knowledge of the product and safety precautions.



Avoid contacts with energised electrical parts. Always disconnect the power supply before connecting, servicing or repairing the product.



Always verify that you apply appropriate power supply to the product and use appropriate wire size and characteristics. Make sure that all the screws and nuts are well tightened and fuses (if any) are fitted well.



Recycling of equipment and packaging should be taken into consideration and these should be disposed of in accordance with local and national legislation / regulations.



In case there are any questions that are not answered, please contact our technical support or consult a professional.

PRODUCT DESCRIPTION

The TVSS5 series control the speed of three-phase 400 V voltage controllable electric motors according to a standard input control signal. They are equipped with Modbus RTU communication and thermal contacts to provide overheating protection of motors with cut-out contacts. They provide a wide range of functionalities: remote control options, adjustable off level, min. and max. output voltage settings, and kickstart or softstart motor acceleration.

ARTICLE CODES

Code	Max. rated current, [A]	Product design	Ingress protection
TVSS5-30CDT	3,0	PCB with modular interface for DIN rail mounting with finger proof cover included	IP20
TVSS5-60CDT	6,0		

INTENDED AREA OF USE

- Fan speed control in ventilation systems where flawless and accurate control is needed
- For indoor use only

TECHNICAL DATA

- Power supply 3 x 400 VAC/50Hz
- Infinitely variable control
- Min. and max. speed internally adjustable
- Off-level selectable by slide switch
- Kickstart or soft start selectable by DIP switch
- 0–10 VDC / 0–20 mA control signal, selectable by DIP switch
- LED indication for normal operation and alarm status
- Minimum and maximum output voltage setting by trimmers or via Modbus
- Off level setting by trimmer or via Modbus
- Modbus RTU (RS485) communication
- Kick start or soft start
- Remote on/off by external switch or via Modbus
- DIN rail mounting
- Analogue input:
 - ▶ voltage: 0–10 VDC
 - ▶ current: 0–20 mA
- Overvoltage and overcurrent protection
- Thermal inputs for motor overheating protection
- Protection standard: IP20 (according to EN 60529)
- Operating ambient conditions:
 - ▶ temperature: -20–40 °C
 - ▶ rel. humidity: < 80 % rH (non-condensing)
- Storage temperature: -40–50 °C

STANDARDS

- Low Voltage Directive 2014/35/EC
- EMC Directive 2014/30/EC
- WEEE Directive 2012/19/EU
- RoHs Directive 2011/65/EU



WIRING AND CONNECTIONS

Wiring and connections		
PE		Earth terminal
N		Neutral
R S T		Three-phase power supply (3 x 400 VAC, 50 Hz)
U V W		Regulated output to three-phase motor
TK		Thermal contact
SW		Remote start / stop
VCC		Power supply for external potentiometer 12 VDC / 1 mA
Ai		Analogue signal (0–10 VDC / 0–20 mA)
GND		Ground
12V		Supply output +12 VDC / 100 mA
A		Modbus RTU (RS485) signal A
/B		Modbus RTU (RS485) signal /B
Connections	Cable cross section	max. 2,5 mm ²

OPERATIONAL DIAGRAMS

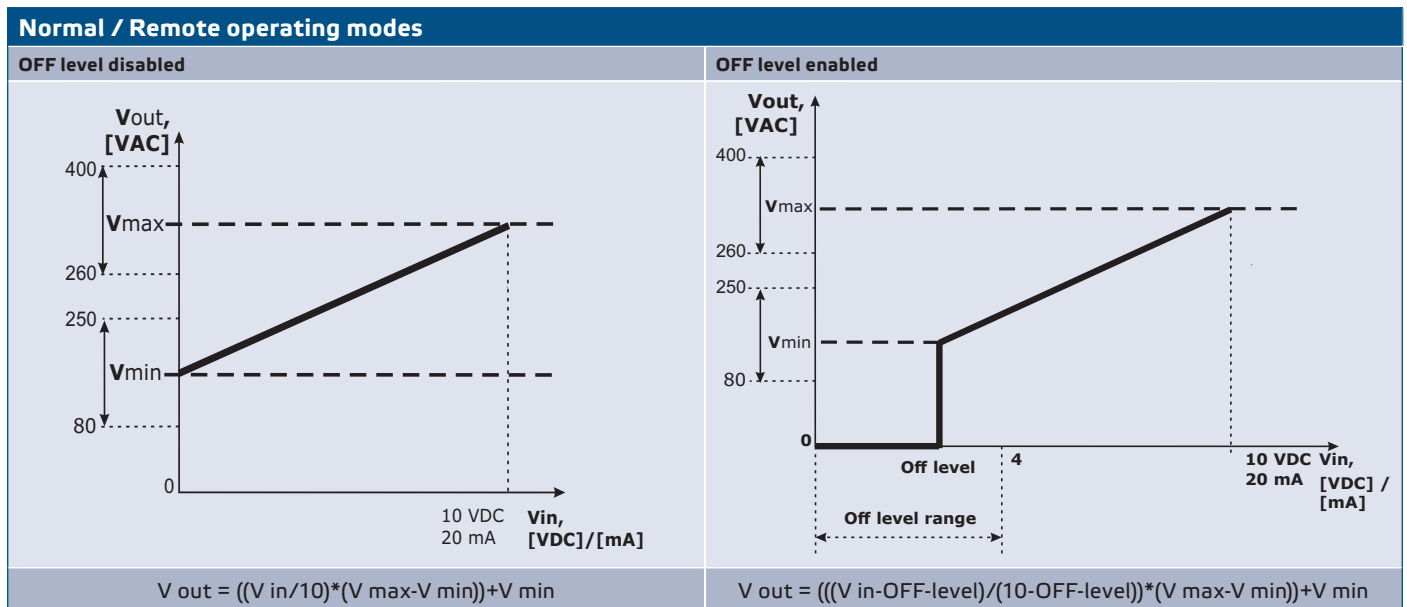

MOUNTING INSTRUCTIONS IN STEPS

Before you start mounting the unit read carefully **“Safety and Precautions”**. Then proceed with the following mounting steps:

1. Switch off the power supply.
2. Remove the transparent cover of the DIN enclosure.
3. Unscrew the side walls of the DIN rail module. Slide the module along the guides of a standard DIN rail. Fix in the desired unit position on the rail by mounting the side walls of the enclosure. Mind the correct position and mounting dimensions shown in **Fig. 1 Mounting dimensions** and **Fig. 2 Mounting position**.

Fig. 1 Mounting dimensions

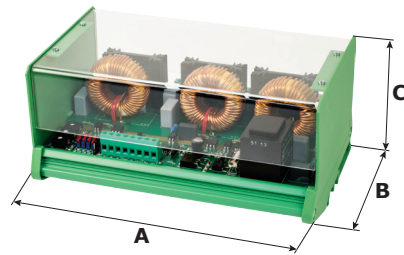

Article	A	B	C
TVSS5-30CDT	195	125	100
TVSS5-60CDT			

Fig. 2 Mounting position

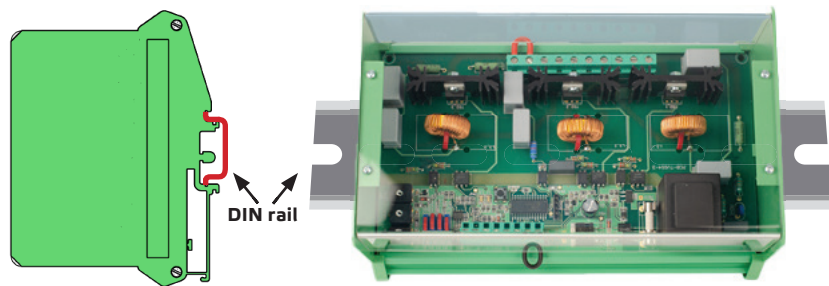

4. Do the wiring according to the wiring diagram (Fig. 3) using the information from section "Wiring and connections".

Fig. 3 Wiring and connections

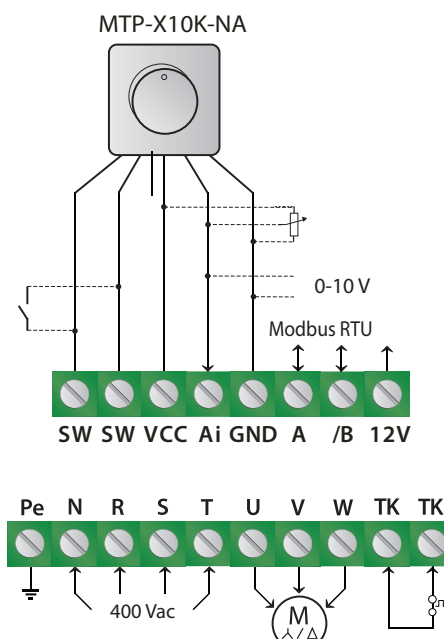

5. Depending on the desired operating mode - standalone or Modbus mode - proceed with one of the following:

1. Standalone mode:

1. Select the required analogue input type and mode, start mode and off level by the DIP switch on the board. (See Fig. 4 DIP switch settings.)

Fig. 4 DIP switch settings



ATTENTION

If an AC power supply is used with any of the units on a Modbus network, the GND terminal should NOT BE CONNECTED to other units on the network or via the CNVT-USB-RS485 converter. This may cause permanent damage to the communication semiconductors and / or the computer!

2. Adjust the max. speed via the trimmer (if necessary). The default setting is Us (400 VAC). See Fig. 5 Max. speed trimmer.
3. Adjust the min. speed via the trimmer (if necessary). The default setting is 80 VAC. See Fig. 6 Min. speed trimmer.
4. Adjust the off level value via the trimmer (if necessary). The default setting is 0 VAC. See Fig. 7 Off level trimmer.

Fig. 5 Max. speed trimmer

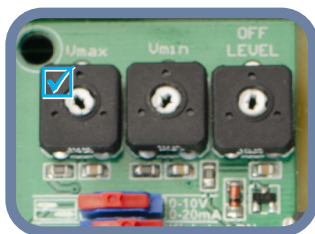

Fig. 6 Min. speed trimmer

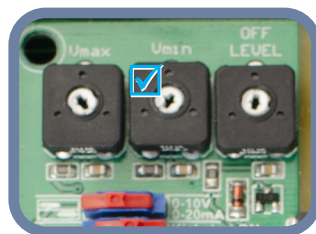
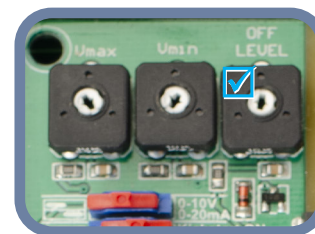

Fig. 7 Off level trimmer



5. Close the enclosure and secure the transparent cover.
6. Switch on the power supply.

2. Modbus RTU mode

1. The device features Modbus RTU communication. This means all the settings can be done using the 3SModbus software or Sensistant (if necessary). Modbus RTU settings have priority over the standalone settings when Modbus is enabled via Holding Register 7. For the default factory setting refer to the product Modbus register map.

NOTE

For the complete Modbus register data, refer to the product Modbus Register Map, which is a separate document attached to the article code on the website and contains the registers list. Products with earlier firmware versions may not be compatible with this list.

Optional settings

To assure correct communication, the NBT needs to be activated in only two devices on the Modbus RTU network. To assure correct communication, the NBT needs to be activated in only two devices on the Modbus RTU network. If necessary, enable the NBT resistor via 3SModbus or Sensistant for Modbus mode or manually for standalone mode (see Fig. 8).

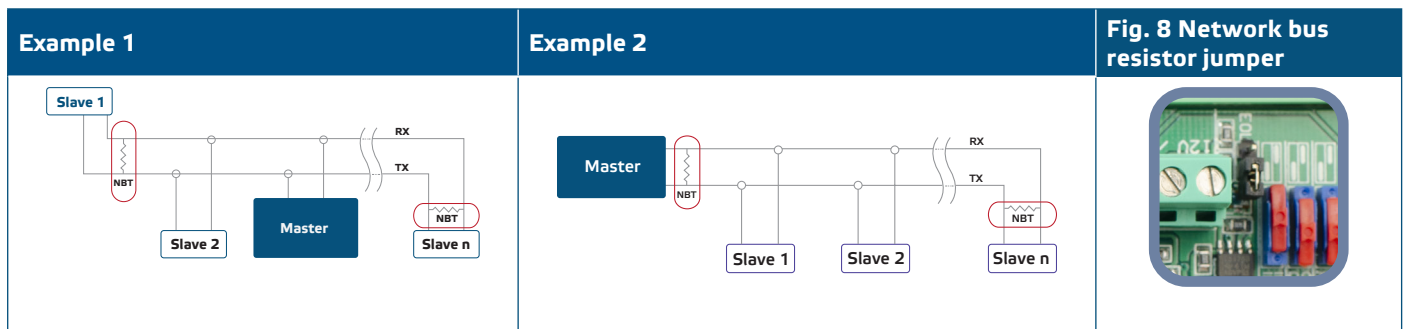

Modbus registers can be reset by pressing the the tact switch button for 4 seconds (see **Fig. 8**).

Fig. 8 Modbus registers reset tact switch

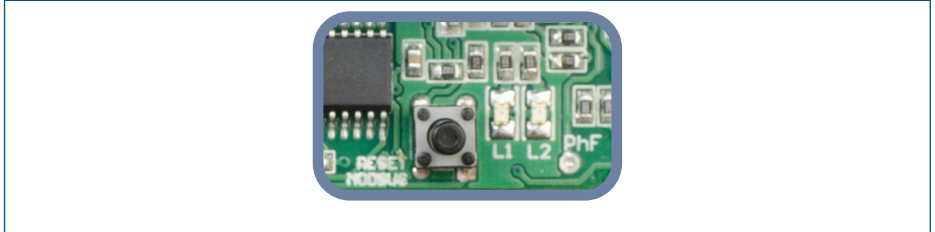

VERIFICATION OF INSTALLATION INSTRUCTIONS

Follow the instructions below:

1. Switch on the mains supply.
2. Set the NBT jumper, DIP switch, Max. trimmer, Min. trimmer and OFF level trimmer to the desired positions / values. The factory settings are as follows:
 - ▶ NBT jumper is disconnected
 - ▶ Ascending mode: 0–10 VDC / 0–20 mA
 - ▶ Off level - OFF;
 - ▶ Kick start disabled;
 - ▶ Input voltage mode (0–10 VDC);
 - ▶ Min. setting of the Min. speed trimmer;
 - ▶ Max. setting of the Max. speed trimmer;
 - ▶ Min. setting of the Off level trimmer.
3. Set the analogue input signal to the maximum value of 10 VDC or 20 mA.
4. The connected motor will run at maximum speed or minimum speed depending on the analogue input mode (ascending / descending).
5. If OFF level is enabled and descending analogue input mode is selected, the motor will stop running.
6. Set the analogue input signal to the maximum value of 0 VDC or 0 mA.
7. The connected fan will run at minimum speed or maximum speed depending on the analogue input mode (ascending / descending).
8. If OFF level is enabled and ascending analogue input mode is selected, the motor will stop running.
9. If OFF level is enabled and the input signal is equal to the value of the OFF level, the speed of the motor will be the minimum speed in ascending mode or the maximum speed in descending mode.
10. If the controller does not work according to the instructions above, the wiring connections and settings need to be checked.
11. Check if both LEDs (**Fig. 10**) blink after you switch on your unit. If they do, your unit has detected Modbus network. If they do not, check the connections again.

Fig. 10 Communication detection indication

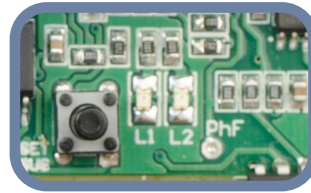

ATTENTION

The status of the LEDs can be checked only when the unit is energised. Take the relevant safety measures!

OPERATING INSTRUCTIONS

OPERATION MODES

In **Modbus mode** you control the parameters: Vmax, Vmin, Kick start / Soft start, Off level enable / disable and Off level value through Modbus registers.

In **Standalone mode** you control the parameters: Vmax, Vmin, Kick start / Soft start, Off level enable / disable and Off level value by means of the hardware settings (DIP switch, trimmers, jumpers).

LED indications

Red on: temperature contact (TK) is open.

Red flashing: missing phase from power supply (R, S, T) or missing phase to load (U, V, W), missing current across triacs.

Green flashing fast (0,5 s light, 0,5 s no light): level of input signal (0-10 V/ 0-20 mA) is smaller than off-level.

Green flashing slow (0,5 s light, 3 s no light): controller is switched off by remote switch, contact SW is open

When the green LED on **Fig. 11** is solid on, the controller operates in normal mode. When it blinks:

- ▶ the controller operates in remote control mode, or
- ▶ OFF level is enabled and the analogue input signal is below the OFF level value.

Fig. 11 Operation indication



TRANSPORT AND STORAGE

Avoid shocks and extreme conditions; stock in original packing.

WARRANTY AND RESTRICTIONS

Two years from the delivery date against defects in manufacturing. Any modifications or alterations to the product after the date of publication relieve the manufacturer of any responsibilities. The manufacturer bears no responsibility for any misprints or mistakes in this data.

MAINTENANCE

In normal conditions this product is maintenance-free. If soiled, clean with a dry or damp cloth. In case of heavy pollution, clean with a non-aggressive product. In these circumstances the unit should be disconnected from the supply. Pay attention that no fluids enter the unit. Only reconnect it to the supply when it is completely dry.