

TCMF8-WF/EW | UNIVERSAL FAN SPEED CONTROLLER

Mounting and operating instructions



Table of contents

SAFETY AND PRECAUTIONS	3
PRODUCT DESCRIPTION	4
ARTICLE CODES	4
INTENDED AREA OF USE	4
TECHNICAL DATA	4
STANDARDS	5
WIRING AND CONNECTIONS	6
LED INDICATIONS	7
MOUNTING INSTRUCTIONS IN STEPS	7
VERIFICATION OF INSTALLATION	10
TRANSPORT AND STORAGE	10
WARRANTY AND RESTRICTIONS	10
MAINTENANCE	10

SAFETY AND PRECAUTIONS



Read all the information, the datasheet, Modbus map, mounting and operating instructions and study the wiring and connection diagram before working with the product. For personal and equipment safety, and for optimum product performance, make sure you entirely understand the contents before installing, using, or maintaining this product.



For safety and licensing (CE) reasons, unauthorised conversion and /or modifications of the product are inadmissible.



The product should not be exposed to abnormal conditions, such as extreme temperatures, direct sunlight or vibrations. Long-term exposure to chemical vapours in high concentration can affect the product performance. Make sure the work environment is as dry as possible; avoid condensation.



All installations shall comply with local health and safety regulations and local electrical standards and approved codes. This product can only be installed by an engineer or a technician who has expert knowledge of the product and safety precautions.



Avoid contacts with energised electrical parts. Always disconnect the power supply before connecting, servicing or repairing the product.



Always verify that you apply appropriate power supply to the product and use appropriate wire size and characteristics. Make sure that all the screws and nuts are well tightened and fuses (if any) are fitted well.



Recycling of equipment and packaging should be taken into consideration and these should be disposed of in accordance with local and national legislation / regulations.



In case there are any questions that are not answered, please contact your technical support or consult a professional.

PRODUCT DESCRIPTION

The TCMF8-WF/EW are universal fan speed controllers with Modbus RTU communication and an integrated internet gateway. Multiple AC fans can be regulated via the two TRIAC outputs (phase angle control). Via Modbus RTU communication one or more HVAC sensors or potentiometers can be connected to this controller. Application specific firmware is required. This firmware can be downloaded via SenteraWeb. Typical applications are destratification, air curtain control, heat recovery unit control, etc. These TCMF8 versions have a built-in internet gateway to connect to SenteraWeb.

ARTICLE CODES

Article code	Ethernet	Wi-Fi	Maximum load
TCMF8-302WF	no	yes	2 x 3 A
TCMF8-602WF	no	yes	2 x 6 A
TCMF8-302EW	yes	yes	2 x 3 A
TCMF8-602EW	yes	yes	2 x 6 A

INTENDED AREA OF USE

- Fan speed control in ventilation systems
- For indoor use only







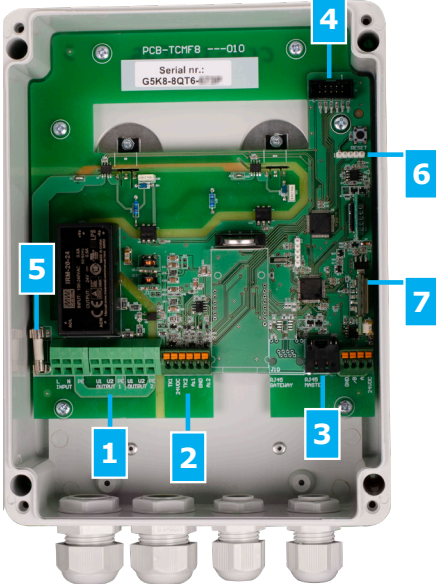
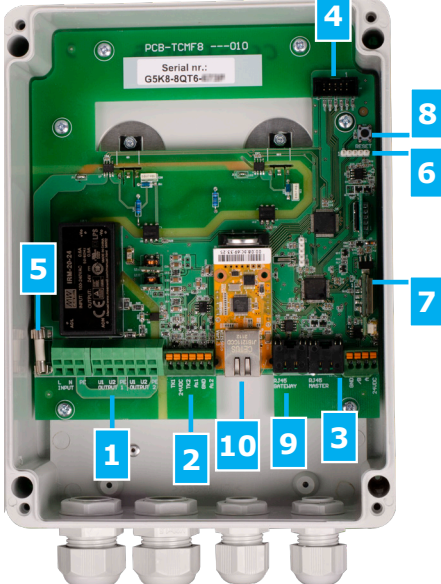
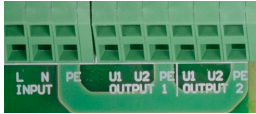

TECHNICAL DATA

- Analogue input signal: 0–10 / 10–0 VDC or 0–20 / 20–0 mA / PWM
- Supply voltage (Us): 85–305 VAC / 50–60 Hz
- 2 regulated outputs: 20–100 % Us
 - ▶ Minimum output voltage selection, Umin: 20–60 % Us
 - ▶ Maximum output voltage selection, Umax: 60–100 % Us
- Two separate TK inputs for thermal motor protection
- Integrated internet connection (Wi-Fi and / or Ethernet)
- Integrated power supply for external sensors: 24 VDC (Imax 750 mA)
- Selectable output voltage for minimum fan speed and maximum fan speed, selection between single output and mirrored or independent double output (application / solution specific).
- RGB-LED on the cover for status indication
- Protection standard: IP54 (according to EN 60529)
- Operating ambient conditions:
 - ▶ Temperature: -10–60 °C
 - ▶ Rel. humidity: 5–95 % rH (non-condensing)

STANDARDS

- Low Voltage Directive 2014/35/EC
 - ▶ EN 60529:1991 Degrees of protection provided by enclosures (IP Code) Amendment AC:1993 to EN 60529
 - ▶ EN 60730-1:2011 Automatic electrical controls for household and similar use - Part 1: General requirements
 - ▶ EN 62311:2008 Assessment of electronic and electrical equipment related to human exposure restrictions for electromagnetic fields (0 Hz - 300 GHz)
 - ▶ EN 60950-1:2006 Information technology equipment - Safety - Part 1: General requirements Amendments AC:2011, A11:2009, A12:2011, A1:2010 and A2:2013 to EN 60950-1
- EMC Directive 2014/30/EC
 - ▶ EN 60730-1:2011 Automatic electrical controls for household and similar use - Part 1: General requirements
 - ▶ EN 61000-3-2:2014 Electromagnetic compatibility (EMC) - Part 3-2: Limits - Limits for harmonic current emissions (equipment input current ≤ 16 A per phase)
 - ▶ EN 61000-6-2:2005 Electromagnetic compatibility (EMC) - Part 6-2: Generic standards - Immunity for industrial environments Amendment AC:2005 to EN 61000-6-2
 - ▶ EN 61000-6-3:2007 Electromagnetic compatibility (EMC) - Part 6-3: Generic standards - Emission standard for residential, commercial and light industrial environments Amendments A1:2011 and AC:2012 to EN 61000-6-3
 - ▶ EN 61326-1:2013 Electrical equipment for measurement, control and laboratory use - EMC requirements - Part 1: General requirements
 - ▶ EN 55011:2009 Industrial, scientific and medical equipment - Radiofrequency disturbance characteristics - Limits and methods of measurement Amendment A1:2010 to EN 55011
 - ▶ EN 55024:2010 Information technology equipment - Immunity characteristics - Limits and methods of measurement
- RoHs Directive 2011/65/EU
 - ▶ EN IEC 63000:2018 Technical documentation for the assessment of electrical and electronic products with respect to the restriction of hazardous substances
- Radio equipment Directive 2014/53/EU:
 - ▶ EN 300 328 V2.1.1 Wideband transmission systems; Data transmission equipment operating in the 2,4 GHz ISM band and using wide band modulation techniques; Harmonised Standard covering the essential requirements of article 3.2 of Directive 2014/53/EU
- ETSI EN 301 489-1 V2.1.1 (2017-02) ElectroMagnetic Compatibility (EMC) standard for radio equipment and services; Part 1:
 - ▶ Common technical requirements; Harmonised Standard covering the essential requirements of article 3.1(b) of Directive 2014/53/EU and the essential requirements of article 6 of Directive 2014/30/EU
- ETSI EN 301 489-17 V3.1.1 (2017-02) ElectroMagnetic Compatibility (EMC) standard for radio equipment and services; Part 17:
 - ▶ Specific conditions for Broadband Data Transmission Systems; Harmonised Standard covering the essential requirements of article 3.1(b) of Directive 2014/53/EU

WIRING AND CONNECTIONS

		Legend	
TCMF8-WF	TCMF8-EW		
			
1 - Terminal block power supply and regulated outputs		Connect the supply voltage to the input (L, N, PE). Connect the AC fans to the outputs taking into account the maximum current.	
2 - Terminal block analogue inputs and thermal protection		If applicable, analogue input signals and motor TK contacts (thermal motor protection) can be connected via this terminal block.	
3 - RJ45 socket and terminal block PoM		External Modbus slave devices can receive power supply (24 VDC) via the RJ45 socket or via the terminal block. Do not connect an external 24 VDC power supply to TCMF8 - this will cause permanent damage. The combined current consumption of the connected slave devices must not exceed 750 mA.	
4 - LED's connector		To connect LED's on cover of casing with circuit board.	
5 - Fuse		TCMF8-302EW	(5*20 mm) T 8,0 A H 250 VAC
		TCMF8-302WF	
6 - PROG header, P1		Put a jumper onto pins 1 and 2 and wait for at least 5 seconds to reset the Modbus communication parameters	
		Put a jumper onto pins 3 and 4 and restart the power supply to enter bootloader mode	
7 - Wi-Fi reset tact switch		Press and hold the reset tact-switch for 2 seconds to remove the actual Wi-Fi network connection. After the Wi-Fi network reset, the default IP-address is restored: 192.168.1.123.	
8 - Wi-fi reset tact switch (EW only)		Push and hold for 4 seconds to perform a reset of the Wi-fi module. After the reset, the unit is traceable as Wi-fi network (XIG) and the configuration page for internet access is accesible via URL: 192.168.1.123 with password 123456798	
9 - RJ45 socket		ATTENTION! Do not connect external power supply to this RJ45 socket.	
10 - Ethernet		To connect the installation to SenteraWeb via a LAN cable	

Wiring and connections		
L	Supply voltage, Line	
N	Supply voltage, Neutral	
Pe	Protective Earth	
U1	Regulated motor output 1	
U2	Regulated motor output 2	
TK1, TK2	Thermal contact inputs	
A	Modbus RTU (RS485) signal A	
/B	Modbus RTU (RS485) signal /B	
Ai1, Ai2	Analogue input 0–10 VDC / 0–20 mA / PWM	
GND	Ground	
Connections	Cable cross section	max. 2,5 mm ²
	Cable gland clamping range	3–6 mm / 5–10 mm
RJ45 socket and terminal block	Attention! External Modbus slave devices can receive power supply (24 VDC) via the RJ45 socket or via the terminal block. Do not connect an external 24 VDC power supply to TCMF8 - this will cause permanent damage.	Modbus RTU signal A and /B, 24 VDC and GND
RJ45 socket (TCMF8-EW)	Ethernet LAN connection	

LED INDICATIONS

Indications	
Green	Active internet connection OK (Senteraweb gateway successfully communicates with the SenteraWeb Broker – sending/receiving data and parameter values of connected slave devices to SenteraWeb and downloading firmware updates in order to flash connected slave devices)
Red	Indicates system error (connection to SenteraWeb has been lost).
Red and pink (fast blinking)	Uploading firmware update for Senteraweb gateway part is in progress.
Blue (long-blink)	Bootloader mode activated, but firmware update process is still not in progress.

MOUNTING INSTRUCTIONS IN STEPS

Before you start mounting the TCMF8-DM, read carefully “**Safety and Precautions**” and follow these steps. Choose a smooth solid wall surface for installation.

Follow these steps:

1. Switch OFF the main power supply.
2. Unscrew the front cover and open the enclosure. Mind the wires that connect the potentiometer with the printed circuit board.
3. Fix the unit onto the wall or panel using the provided screws and dowels. Mind the correct mounting position and unit mounting dimensions. (See **Fig. 1 Mounting dimensions** and **Fig. 2 Mounting position**.)
4. Pay attention to the following instructions in order to minimize the operating temperature:
 - ▶ Respect the distances both between the wall / ceiling and the device and between two devices as shown in **Fig. 2**. In order to ensure sufficient ventilation of the controller, clearance on every side has to be maintained.
 - ▶ When installing the device, please keep in mind that the higher you install it, the warmer the device will get. For example, in a technical room the correct installation height can be of great importance.

5. Insert the cables through the cable glands and do the wiring according to the wiring diagram (see "Wiring and connections") while adhering to the information from section "Wiring and connections".
 - ▶ Connect the AC fans (terminals U2, U1 and PE);
 - ▶ Connect the supply voltage (terminals L, N and PE);
 - ▶ Connect the sensors via the RJ45 socket or via the Modbus terminal block.
 - ▶ If applicable, connect the analogue input signal(s)
6. Put back the cover and secure it with the screws. Tighten the cable glands.
7. Switch on the power supply.
8. Connect your installation to SenteraWeb and download the required application specific firmware.
9. Switch ON the main supply after all connections are done and checked.

***Not respecting the above listed rules can reduce service life and relieves the manufacturer of any responsibilities.**

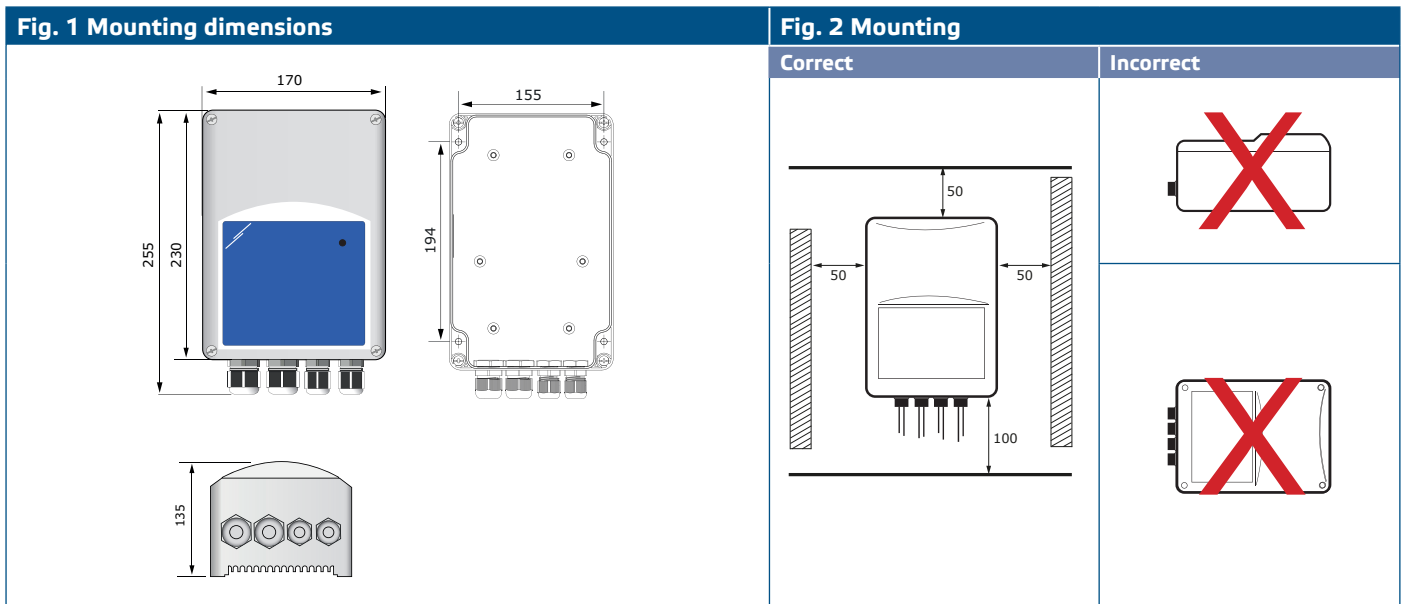

ATTENTION

This controller requires application specific firmware. This firmware can be downloaded via www.senteraweb.eu

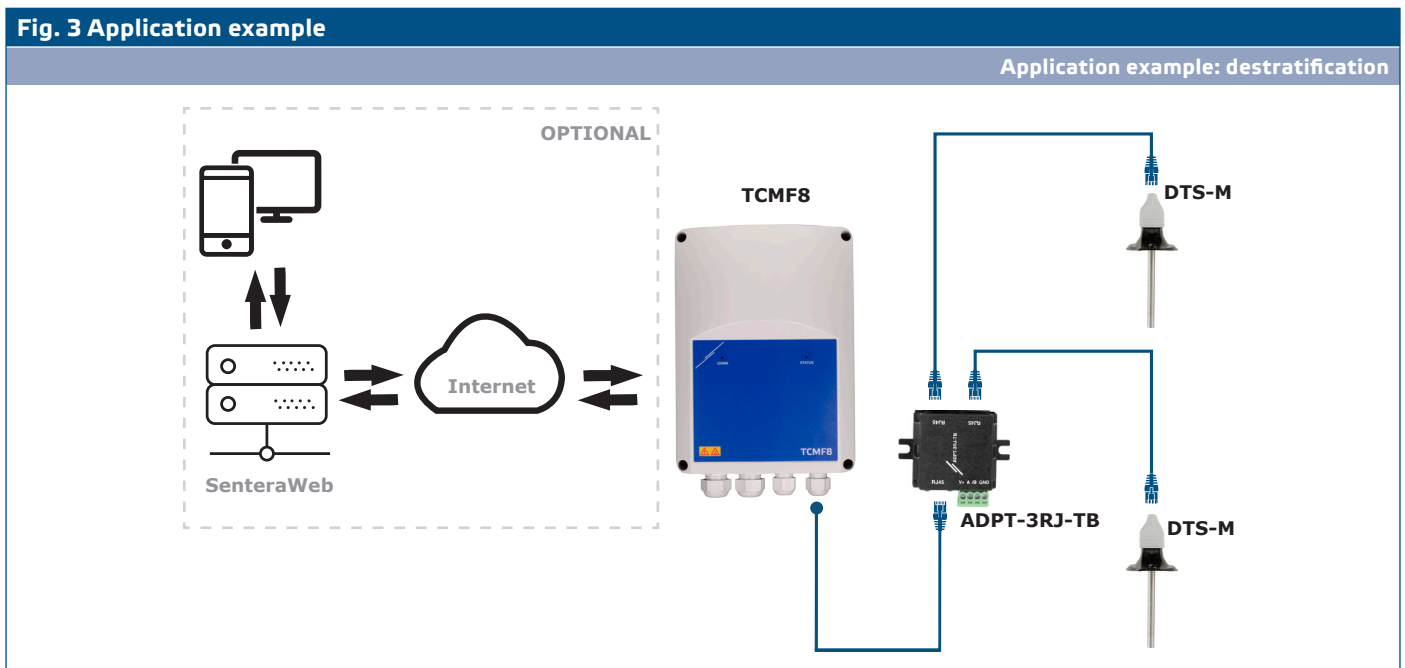

Download and Install Sentera Solution Firmware

The TCMF8 controller requires application dedicated firmware, which can be downloaded from the Sentera website: Select your application via www.sentera.eu/en/solutions.

First, connect all required products including the Sentera internet gateway. Then connect your installation to www.senteraweb.eu. Enter the solution code and click "Link to solution" to download the selected firmware into the connected devices. After the download there is the possibility to use the installation stand alone or to keep the internet gateway connected.

Tact switch

Press and hold the tact switch for at least 5 seconds to reset the unit to its default values:

- default Connection Type: Ethernet
- default Connection mode: DHCP
- default Modbus communication parameters: 19200 Bps, 8 bits, even parity, 1 stop bit (8,E,1)
- default gateway host page: 192.168.1.123

Fig. 4 Tact switch

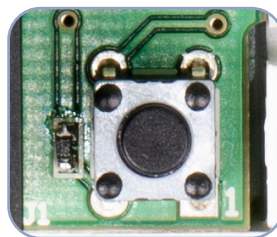

Reset buttons

1. Left button - for Wi-Fi reset

In case of connection problems or in order to clean the memory of the Wi-Fi module, press and hold for 4 seconds until the blue LED (LED2) lights up (see Fig. 5). After this, the password inside the memory (to connect to a Wi-Fi Access point) has been erased and the default IP address 192.168.1.123 is restored. Now you can restart the installation procedure as explained in the User Guide that can be downloaded from the Sentera Website.

2. Right button - for developers only!

The 'Program' button (see Fig. 5) is only needed to restart the microcontroller of the unit for development or debug purposes, such as to enter bootloader mode to reprogram the module. You should NOT press this button in any other cases!

Fig. 5 Wi-Fi reset tact switch

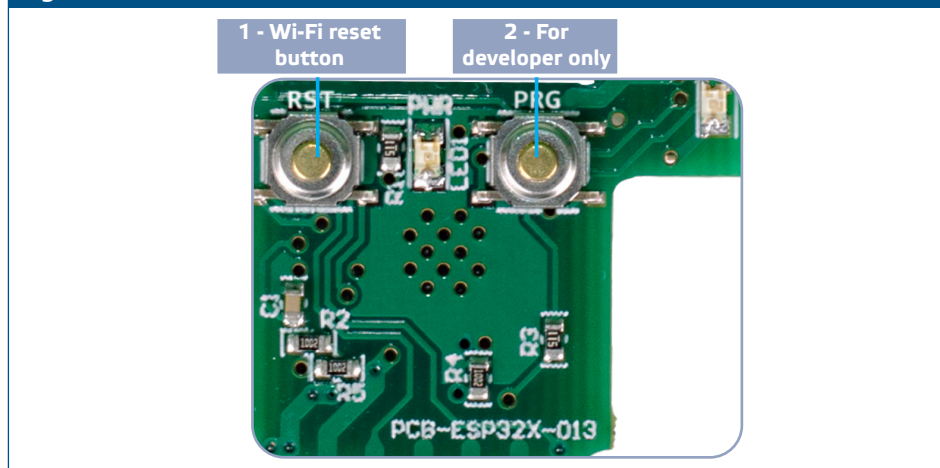

VERIFICATION OF INSTALLATION

After connecting the unit to the main supply, the green LED on its cover should light up to indicate that the controller is supplied.

Safe operation depends on proper installation. Before start up, ensure the following:

- The main supply is connected correctly.
- There is sufficient air flow around the unit.
- Minimum voltage is selected based on the fan parameters - the entire fan regulation range must be within its operating voltage.
- Maximum load current is according to the device selected, make sure the current drawn by the fan does not exceed the current rating of the device!
- During operation, the unit must be closed.
- If the unit does not work according to the instructions, the wiring connections and settings need to be checked.

ATTENTION

Disconnect main power supply before all servicing and maintenance. High Voltage on the internal circuit!

ATTENTION

High temperatures may occur during operation. Allow to cool before maintenance!

ATTENTION

Drawing excessive current from the fan controller will cause the internal circuit to overheat and fail.

TRANSPORT AND STORAGE

Avoid shocks and extreme conditions; stock in original packing.

WARRANTY AND RESTRICTIONS

Two years from the delivery date against defects in manufacturing. Any modifications or alterations to the product after the date of publication relieve the manufacturer of any responsibilities. The manufacturer bears no responsibility for any misprints or mistakes in this data.

MAINTENANCE

In normal conditions this product is maintenance-free. If soiled, clean with a dry or damp cloth. In case of heavy pollution, clean with a non-aggressive product. In these circumstances the unit should be disconnected from the supply. Pay attention that no fluids enter the unit. Only reconnect it to the supply when it is completely dry.