

RSMFM-3 | MULTIFUNCTIONAL CO₂ ROOM TRANSMITTER, POWER OVER MODBUS

Mounting and operating instructions



Table of contents

SAFETY AND PRECAUTIONS	3
PRODUCT DESCRIPTION	4
ARTICLE CODE	4
INTENDED AREA OF USE	4
TECHNICAL DATA	4
STANDARDS	4
OPERATIONAL DIAGRAMS	5
WIRING AND CONNECTIONS	5
MOUNTING & OPERATING INSTRUCTIONS IN STEPS	6
OPERATING INSTRUCTIONS	8
VERIFICATION OF INSTALLATION	9
TRANSPORT AND STORAGE	9
WARRANTY AND RESTRICTIONS	9
MAINTENANCE	9

SAFETY AND PRECAUTIONS



Read all the information, the datasheet, Modbus Register map, mounting and operating instructions and study the wiring and connection diagram before working with the product. For personal and equipment safety, and for optimum product performance, make sure you entirely understand the content before installing, using or maintaining this product.



Unauthorised conversion and/or modification of the product is not permitted for safety and licensing (CE) reason



The product should not be exposed to abnormal conditions, such as extreme temperatures, direct sunlight or vibrations. Long-term exposure to chemical vapours in high concentration can affect the product performance. Make sure the work environment is as dry as possible and avoid condensation.



All installations shall comply with local health and safety regulations, local electrical standards and approved codes. This product can only be installed by an engineer or a technician who has expert knowledge of the product and of the safety precautions.



Avoid contact with energised electrical parts. Always disconnect the power supply before connecting, servicing or repairing the product.



Always ensure that the product is powered properly and that the wire size and characteristics are appropriate. Make sure that all the screws and nuts are well tightened and fuses (if any) are fitted well.



Recycling of equipment and packaging should be taken into consideration and these should be disposed of in accordance with local and national legislation / regulations.



If you have any further questions, please contact your technical support or consult a professional.

PRODUCT DESCRIPTION

The RSMFM-3 are multifunctional room transmitters which measure CO₂ concentration levels, temperature, relative humidity and ambient light. They are Power over Modbus supplied and all parameters are accessible via Modbus RTU.

ARTICLE CODE

Article code	Supply	I _{max}	Connection type
RSMFM-3	24 VDC, PoM	30 mA	RJ45 socket

INTENDED AREA OF USE

- Monitoring temperature, relative humidity and CO₂ levels in HVAC applications
- Appropriate for residential and commercial buildings
- For indoor use only

TECHNICAL DATA

- Selectable temperature, relative humidity and CO₂ ranges
- Ambient light sensor with adjustable 'active' and 'standby' level
- Outputs available via Modbus RTU input registers
- 3 LEDs for status indication with adjustable light intensity
- Accuracy: ±0,5 °C (5–50 °C); ±6 % rH (20–80 % rH); ±(50 ppm + 3% of the reading) CO₂ within the range 400–2.000 ppm, ±(40 ppm + 5% of the reading) CO₂ within the range 2.001–5.000 ppm
- Enclosure:
 - ▶ rear plate: plastic ABS, black (RAL 9004)
 - ▶ front cover: ASA, ivory (RAL 9010)
- Protection standard: IP30 (according to EN 60529)
- Typical range of use:
 - ▶ temperature: 0–50 °C
 - ▶ rel. humidity: 0–95 % rH, (non-condensing)
 - ▶ CO₂: 400–2.000 ppm
- Storage temperature: -10–60 °C

STANDARDS

- EMC directive 2014/30/EU CE
 - ▶ EN 60730-1:2011 Automatic electrical controls for household and similar use - Part 1: General requirements
 - ▶ EN 61000-6-1:2007 Electromagnetic compatibility (EMC) - Part 6-1: Generic standards - Immunity for residential, commercial and light industrial environments
 - ▶ EN 61000-6-3:2007 Electromagnetic compatibility (EMC) - Part 6-3: Generic standards - Emission standard for residential, commercial and light-industrial environments Amendments A1:2011 and AC:2012 to EN 61000-6-3
 - ▶ EN 61326-1:2013 Electrical equipment for measurement, control and laboratory use - EMC requirements - Part 1: General requirements
 - ▶ EN 61326-2-3:2013 Electrical equipment for measurement, control and laboratory use - EMC requirements - Part 2-3: Particular requirements Test configuration, operational conditions and performance criteria for transmitters with integrated or remote signal conditioning
- Low Voltage Directive 2014/35/EU
 - ▶ EN 60529:1991 Degrees of protection provided by enclosures (IP Code) Amendment AC:1993 to EN 60529
 - ▶ EN 60730-1:2011 Automatic electrical controls for household and similar use - Part 1: General requirements
- WEEE 2012/19/EC

- RoHs Directive 2011/65/EC
 - ▶ EN IEC 63000:2018 Technical documentation for the assessment of electrical and electronic products with respect to the restriction of hazardous substances

OPERATIONAL DIAGRAMS

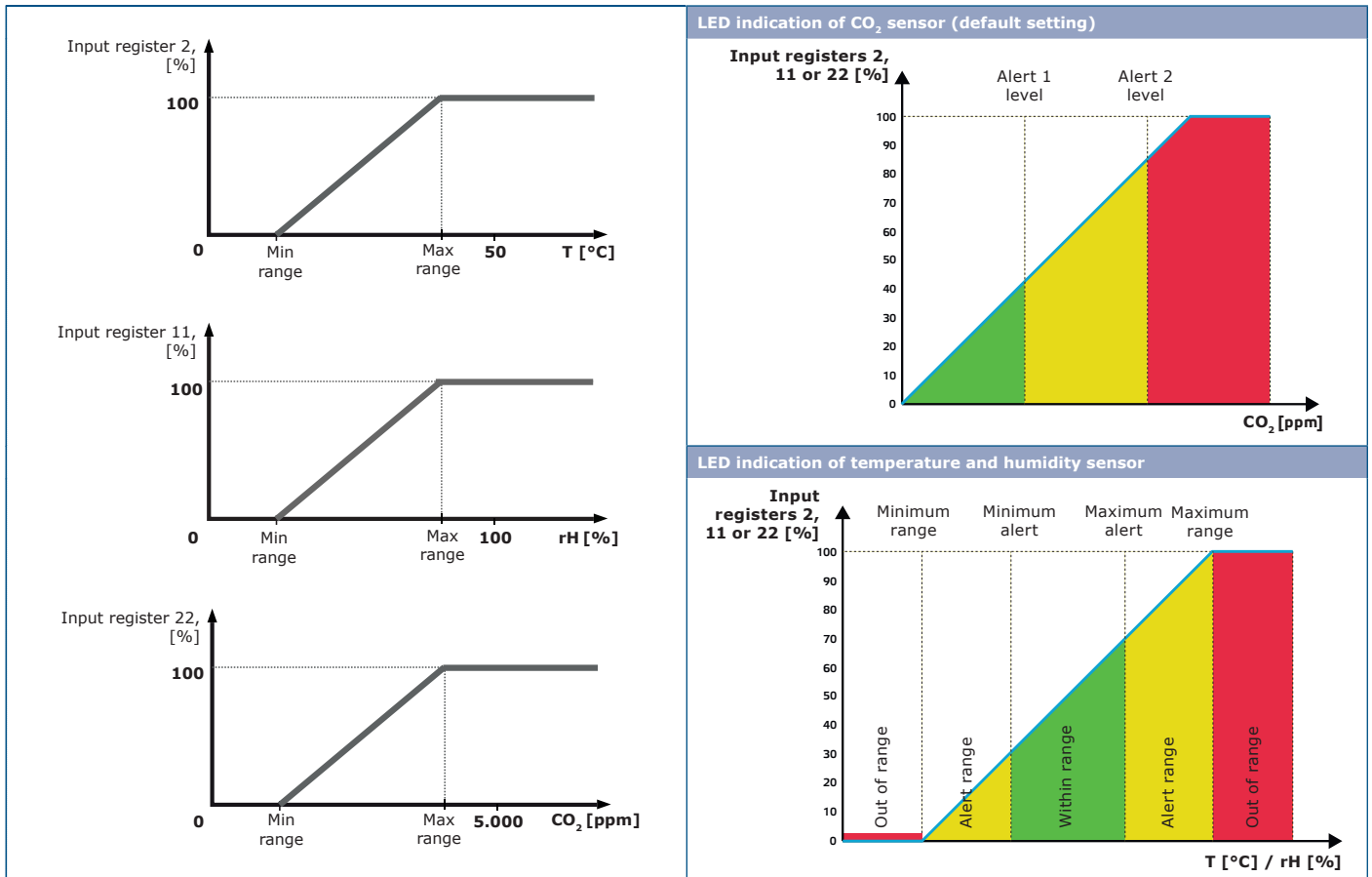

WIRING AND CONNECTIONS

RJ45 socket (Power over Modbus)		
Pin 1	24 VDC	Supply voltage
Pin 2		
Pin 3	A	Modbus RTU communication, signal A
Pin 4		
Pin 5	/B	Modbus RTU communication, signal /B
Pin 6		
Pin 7	GND	Ground, supply voltage
Pin 8		

MOUNTING & OPERATING INSTRUCTIONS IN STEPS

Before you start mounting the unit, read carefully **“Safety and Precautions”**. Choose a smooth surface for installation (a wall, panel, etc.).

⚠ ATTENTION

Mount the sensor in a well-ventilated area where it receives adequate airflow for proper operation and hide it from direct sunlight. Make sure it can be easily accessed for service.

Follow these steps:

1. Release the snap-fits on both sides of the front white cover using a flat screwdriver and remove the cover (see **Fig. 1 Snap-fits release**).
2. Insert the cables through the hole in the back (see **Fig. 2 Mounting dimensions**).
3. Position the room sensor at least 1,5 metres above the ground using suitable fastening materials (not included). Mind the correct mounting position and unit dimensions. See **Fig. 2** and **Fig. 3**.

Fig. 1 Snap-fits release

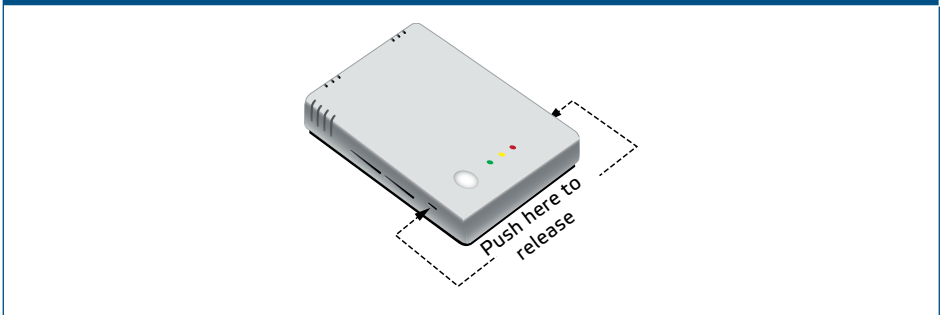
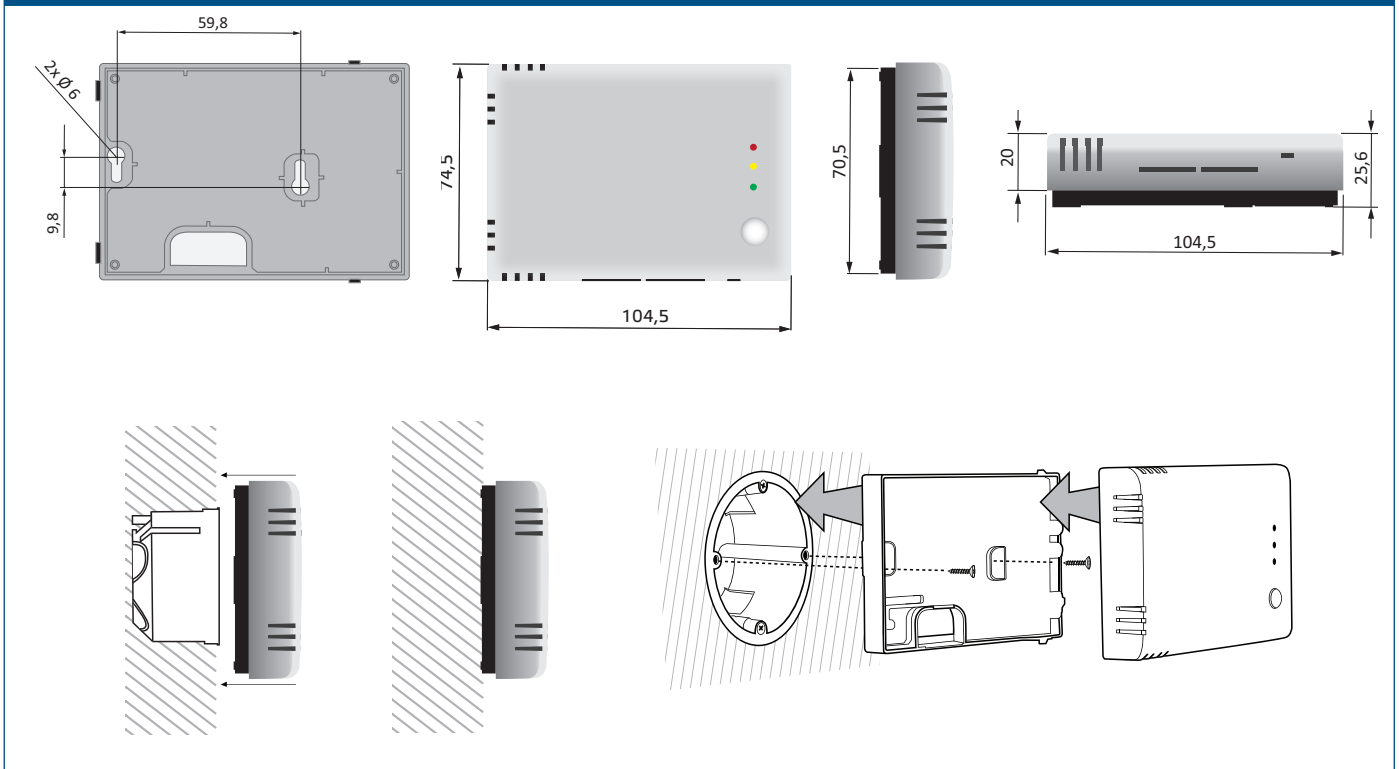
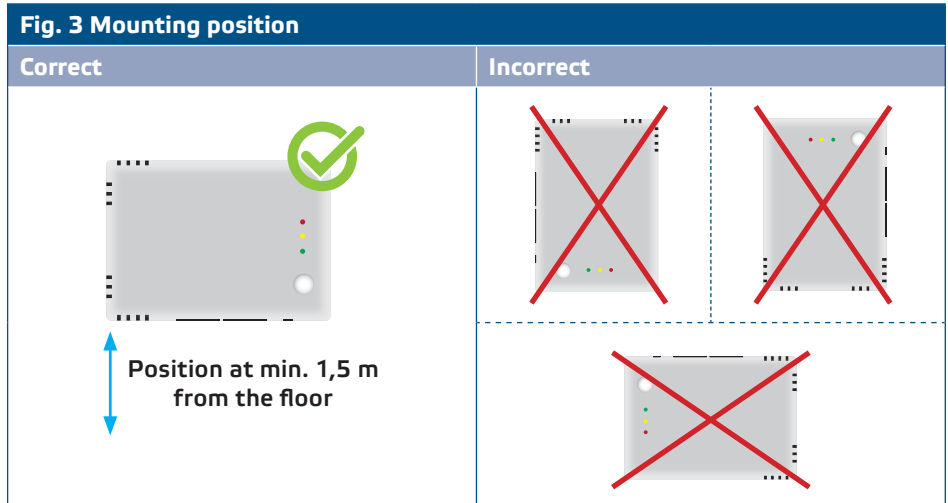
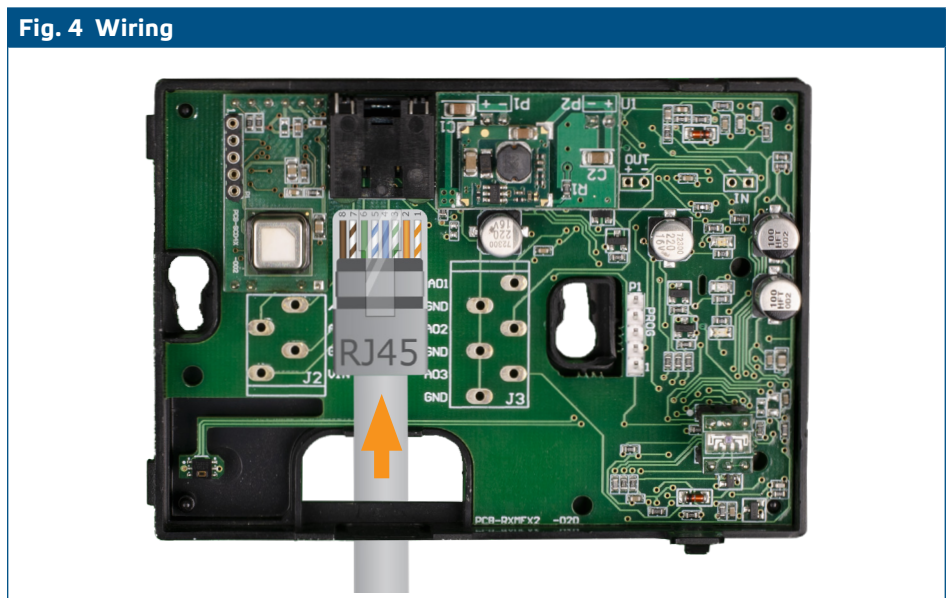

Fig. 2 Mounting dimensions





4. Do the wiring according to the wiring diagram (see Fig. 4).



5. Snap the cover back in place.
6. Switch on the mains supply.
7. Customise the factory settings to the desired ones via the 3SModbus software or SenteraWeb. For the default factory setting see the *Modbus register map* of the product.

Optional settings

To assure correct communication, the NBT needs to be activated in only two devices on the Modbus RTU network. If necessary, enable the NBT resistor via 3SModbus or Sensistant (*Holding register 9*).

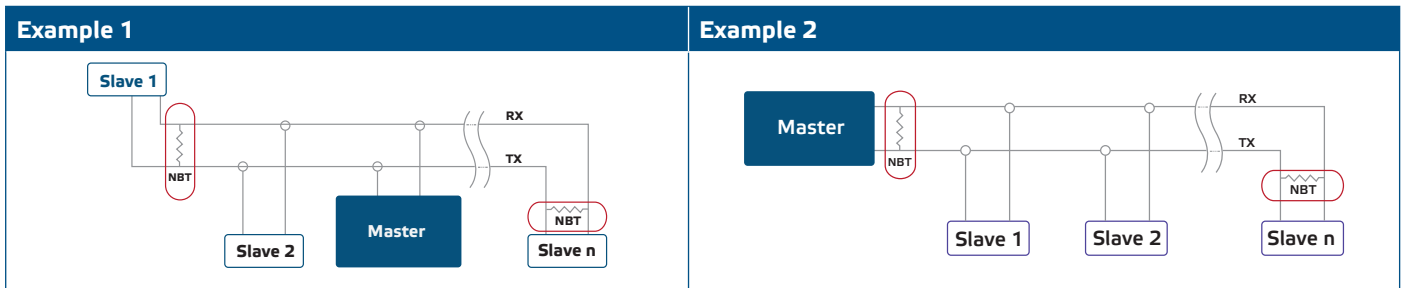

**NOTE**

Two bus terminators (NBTs) must be activated on a Modbus RTU network.

**NOTE**

For the complete Modbus register data, see the Modbus Register Map of the product. This is a separate document linked to the article code on the website containing the list of registers. Products with earlier firmware versions may not be compatible with this list.

OPERATING INSTRUCTIONS

Calibration procedure

There is no need to calibrate temperature or relative humidity. Each sensor element undergoes testing and calibration in our factory.

The CO₂ sensor element is self-calibrating to compensate sensor drift. By default, the ABC logic self-calibrating algorithm is enabled. This algorithm is designed to be used in applications where CO₂ concentrations will drop to outside ambient conditions (400 ppm) at least once a week, typically during unoccupied periods. It is advisable to disable the self-calibrating algorithm in situations where the CO₂ level will not drop to 400 ppm within the mentioned period.

Firmware update

Through a firmware update, new features and bug fixes are made available. Your device can be updated if the most recent firmware is not already installed. The simplest way to update the firmware is through SenteraWeb. The 3SM boot application, which is a part of the Sentera 3SMcenter software suite, can be used to update the firmware if you do not have access to an internet gateway.

**NOTE**

Make sure the power supply does not get interrupted during the "bootload" procedure, otherwise you risk losing unsaved data.

LED indications

1. When the green LED is on, the measured temperature or relative humidity value lies within the alert range's minimum and maximum values or the CO₂ level is below Alert 1 level. (**Fig. 5 - 1**).
2. When the yellow LED is on, the measured temperature or relative humidity value lies in the alert range or the CO₂ value is higher than or equal to Alert 1 level (**Fig. 5 - 2**).
3. When the red LED is on, the measured temperature or relative humidity value is lower than or equal to the minimum measurement range value or higher than or equal to the maximum measurement range value or when the measured CO₂ level is greater than or equal to Alert 2 level. Blinking red LED indicates loss of communication with a sensor (**Fig. 5 - 3**).

**NOTE**

When the sensor is in bootloader mode, the green and yellow LEDs flash alternately. During the firmware download, the red LED is flashing additionally.

Fig. 5 LED indications

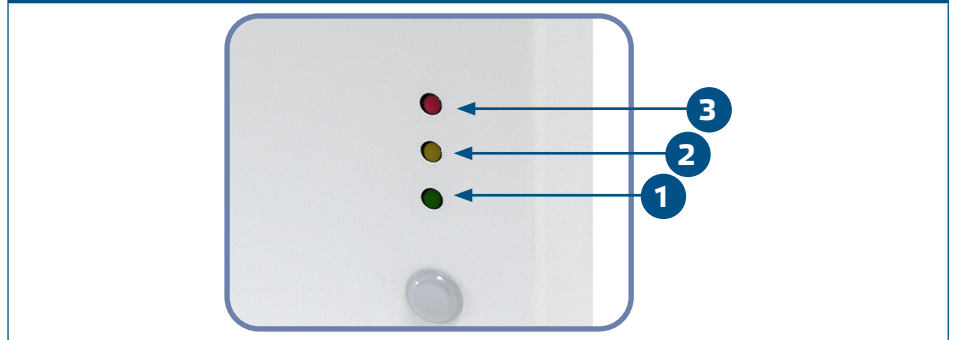
**NOTE**

By default, the LED indication refers to CO₂ measurements. This can be changed to temperature or relative humidity values via Modbus Holding Register 79 (see Table Holding registers).

**NOTE**

The intensity of the LEDs can be adjusted between 0 and 100 % with a step of 10 % according to the value set in Holding register 80.

Ambient light sensor

The Input Register 41 holds the measured light intensity in lux. In Holding registers 35 and 36, an active and standby level can also be specified. If the measured value is below the standby level, above the active level, or somewhere in between, Input Register 42 will indicate that:

- Ambient light level < standby level: Input Register 42 indicates "Standby".
- Ambient light level > active level: Input Register 42 indicates "Active".
- Standby level < Ambient light level < Active level: Input Register 42 indicates "Low intensity".

VERIFICATION OF INSTALLATION

One of the LEDs lights up after the power is turned on, depending on the status of the variable being measured. Check the connections if this is not the case.

TRANSPORT AND STORAGE

Avoid shocks and extreme conditions; stock in original packing.

WARRANTY AND RESTRICTIONS

The warranty against manufacturing flaws is valid for two years starting from the date of delivery. Any alterations or adjustments to the product absolve the manufacturer of all liability. The manufacturer disclaims all liability for typographical or other errors in this document.

MAINTENANCE

In normal conditions this product is maintenance-free. If soiled, clean with a dry or damp cloth. In case of heavy pollution, clean with a non-aggressive product. In these circumstances the unit should be disconnected from the supply. Pay attention that no fluids enter the unit. Only reconnect it to the supply when it is completely dry.