

RCTHX-2

INTELLIGENT
TEMPERATURE AND
HUMIDITY ROOM
SENSOR

Mounting and operating instructions



Table of contents

SAFETY AND PRECAUTIONS	3
PRODUCT DESCRIPTION	4
ARTICLE CODE	4
INTENDED AREA OF USE	4
TECHNICAL DATA	4
STANDARDS	4
OPERATIONAL DIAGRAMS	5
WIRING AND CONNECTIONS	6
MOUNTING & OPERATING INSTRUCTIONS IN STEPS	6
OPERATING INSTRUCTIONS	8
VERIFICATION OF INSTALLATION INSTRUCTIONS	9
TRANSPORT AND STORAGE	9
WARRANTY AND RESTRICTIONS	9
MAINTENANCE	9

SAFETY AND PRECAUTIONS



Read all the information, the datasheet, Modbus map, mounting and operating instructions and study the wiring and connection diagram before working with the product. For personal and equipment safety, and for optimum product performance, make sure you entirely understand the contents before installing, using, or maintaining this product.



For safety and licensing (CE) reasons, unauthorised conversion and /or modifications of the product are inadmissible.



The product should not be exposed to abnormal conditions, such as extreme temperatures, direct sunlight or vibrations. Long-term exposure to chemical vapours in high concentration can affect the product performance. Make sure the work environment is as dry as possible; avoid condensation.



All installations shall comply with local health and safety regulations and local electrical standards and approved codes. This product can only be installed by an engineer or a technician who has expert knowledge of the product and safety precautions.



Avoid contacts with energised electrical parts. Always disconnect the power supply before connecting, servicing or repairing the product.



Always verify that you apply appropriate power supply to the product and use appropriate wire size and characteristics. Make sure that all the screws and nuts are well tightened and fuses (if any) are fitted well.



Recycling of equipment and packaging should be taken into consideration and these should be disposed of in accordance with local and national legislation / regulations.



In case there are any questions that are not answered, please contact your technical support or consult a professional.

PRODUCT DESCRIPTION

The RCTHX-2 are intelligent room sensors featuring adjustable temperature and relative humidity ranges. Their algorithm controls a single analogue / modulating output based on the measured temperature and humidity values, which can be used to directly control an EC fan or an actuator powered damper. All parameters are accessible via Modbus RTU.

ARTICLE CODE

Article code	Supply	I _{max}
RCTHG-2	18–34 VDC	40 mA
	15–24 VAC ±10%	45 mA
RCTHF-2	18–34 VDC	40 mA

INTENDED AREA OF USE

- Ventilation based on temperature and relative humidity levels in residential and commercial buildings
- Demand controlled ventilation
- For indoor use only

TECHNICAL DATA

- Fan speed control based on temperature and relative humidity
- Analogue / modulating output type:
 - ▶ 0–10 VDC mode: $R_L \geq 50 \text{ k}\Omega$
 - ▶ 0–20 mA mode: $R_L \leq 500 \Omega$
 - ▶ PWM (open-collector type) mode: PWM frequency: 1 kHz, $R_L \geq 50 \text{ k}\Omega$; PWM voltage level 3,3 or 12 VDC
- Selectable temperature range: 0–50 °C
- Selectable relative humidity range: 0–100 %
- 3 LEDs with adjustable light intensity for status indication
- Accuracy: ±0,4 °C (range 0–50 °C); ±3 % rH (range 0–95 % rH);
- Enclosure:
 - ▶ rear plate: plastic ABS, black (RAL 9004)
 - ▶ front cover: plastic ASA, ivory (RAL 9010)
- Protection standard: IP30 (according to EN 60529)
- Typical field of use:
 - ▶ temperature: 0–50 °C
 - ▶ rel. humidity: 0–95 % rH, (non-condensing)
- Storage temperature: -10–60 °C

STANDARDS

- EMC directive 2014/30/EU: CE
 - ▶ EN 60529:1991 Degrees of protection provided by enclosures (IP Code) Amendment AC:1993 to EN 60529
- EMC Directive 2014/30/EC;
 - ▶ EN 60730-1:2011 Automatic electrical controls for household and similar use - Part 1: General requirements
 - ▶ EN 61000-6-1:2007 Electromagnetic compatibility (EMC) - Part 6-1: Generic standards - Immunity for residential, commercial and light industrial environments
 - ▶ EN 61000-6-3:2007 Electromagnetic compatibility (EMC) - Part 6-3: Generic standards - Emission standard for residential, commercial and light-industrial environments Amendments A1:2011 and AC:2012 to EN 61000-6-3

- ▶ EN 61326-1:2013 Electrical equipment for measurement, control and laboratory use - EMC requirements - Part 1: General requirements
- ▶ EN 61326-2-3:2013 Electrical equipment for measurement, control and laboratory use - EMC requirements - Part 2-3: Particular requirements - Test configuration, operational conditions and performance criteria
- WEEE 2012/19/EC
- RoHs Directive 2011/65/EC

OPERATIONAL DIAGRAMS

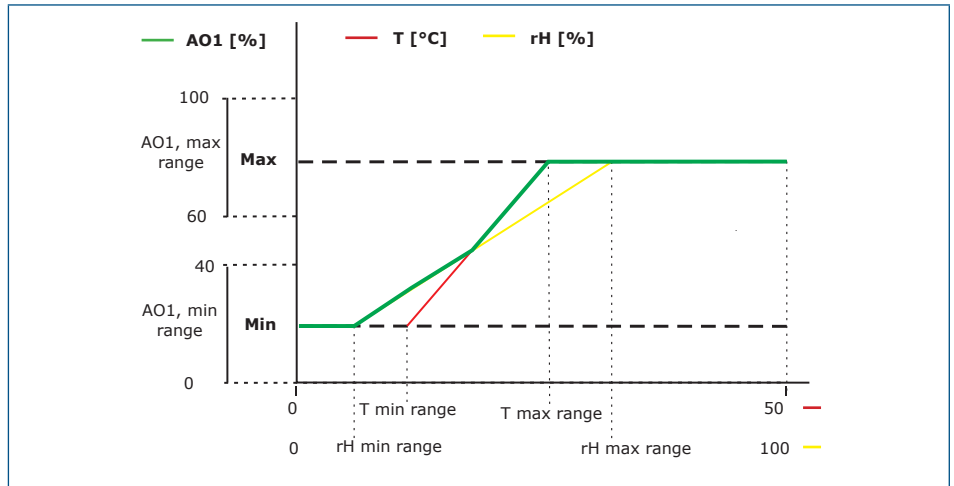

CAUTION

The output changes automatically depending on the higher of the T and rH values, i.e. the higher of the two output values controls the output. See the green line in the operational diagram above.

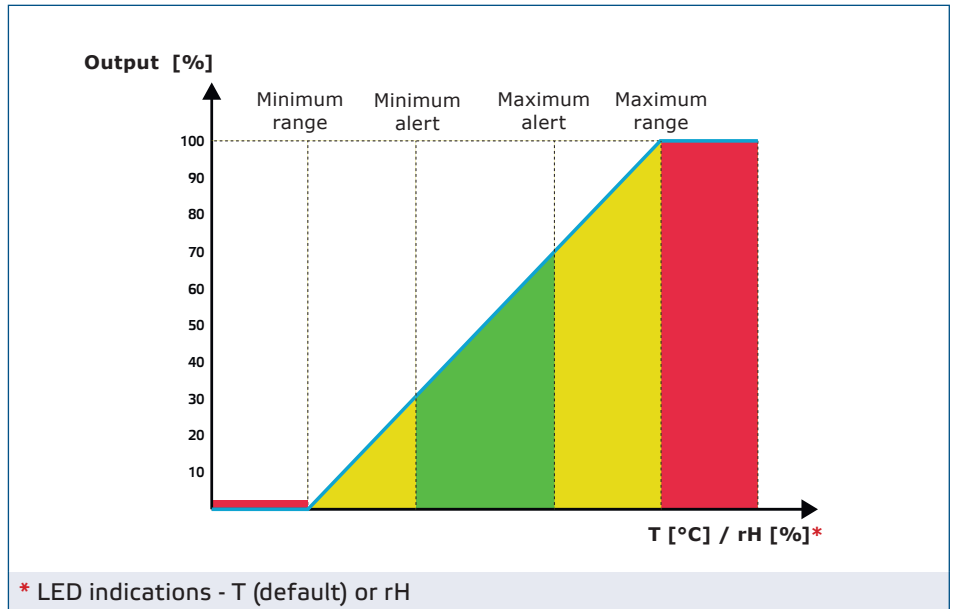

* LED indications - T (default) or rH

WIRING AND CONNECTIONS

Article type	RCTHF-2	RCTHG-2	
VIN	18–34 VDC	18–34 VDC	15–24 VAC ±10%
GND	Ground	Common ground	AC ~
A	Modbus RTU (RS485), signal A		
/B	Modbus RTU (RS485), signal /B		
AO1	Analogue / modulating output - T or rH (0–10 VDC / 0–20 mA / PWM)		
GND	Ground AO1	Common ground	
Connections	Spring contact terminal blocks, cable cross section: 1,5 mm ²		

ATTENTION

The -F version of the product is not suited for 3-wire connection. It has separate grounds for power supply and analogue output. Connecting both grounds together might result in incorrect measurements. Minimum 4 wires are required to connect -F type sensors.

The -G version is intended for 3-wire connection and features a 'common ground'. This means that the ground of the analogue output is internally connected with the ground of the power supply. For this reason, -G and -F types cannot be used together on the same network. Never connect the common ground of -G type articles to other devices powered by a DC voltage. Doing so might cause permanent damage to the connected devices.

MOUNTING & OPERATING INSTRUCTIONS IN STEPS

Before you start mounting the unit, read carefully **"Safety and Precautions"**. Choose a smooth surface for installation (a wall, panel and etc.).

ATTENTION

Mount the sensor in a well-ventilated area, where it receives adequate airflow for proper operation and hide it from direct sunlight. Make sure it can be easily accessed for service.

Follow these steps:

1. Using a flat screwdriver, remove the front white cover by releasing the snap-fits on its both sides (see **Fig. 1** *Snap-fits release*).
2. Insert the cables through the opening on the rear plate (see **Fig. 2** *Mounting dimensions*.)
3. Using suitable fastening materials (not supplied), position the room sensor at least 1,5 m from the floor. When planning the installation, allow enough clearance for maintenance and service. Mount the sensor in a well-ventilated area. Mind the correct mounting position and unit dimensions. See **Fig. 2** and **Fig. 3**.

Fig. 1 Snap-fits release

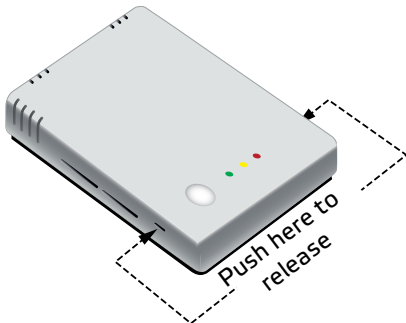

Fig. 2 Mounting dimension

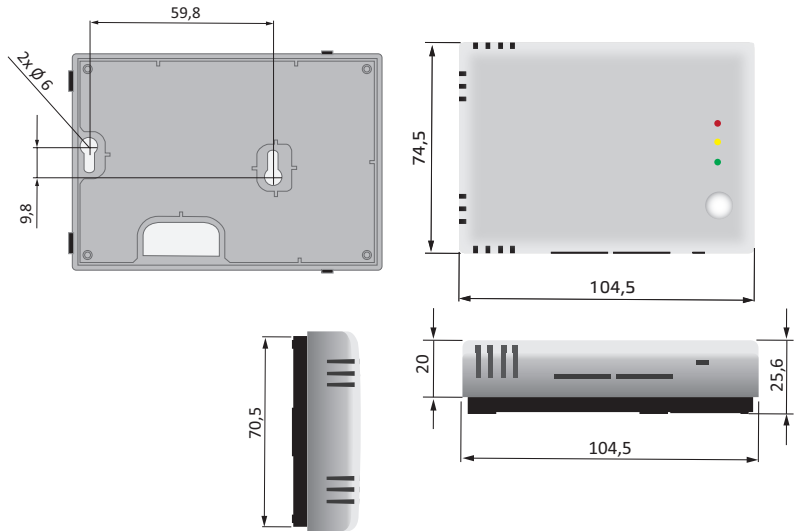
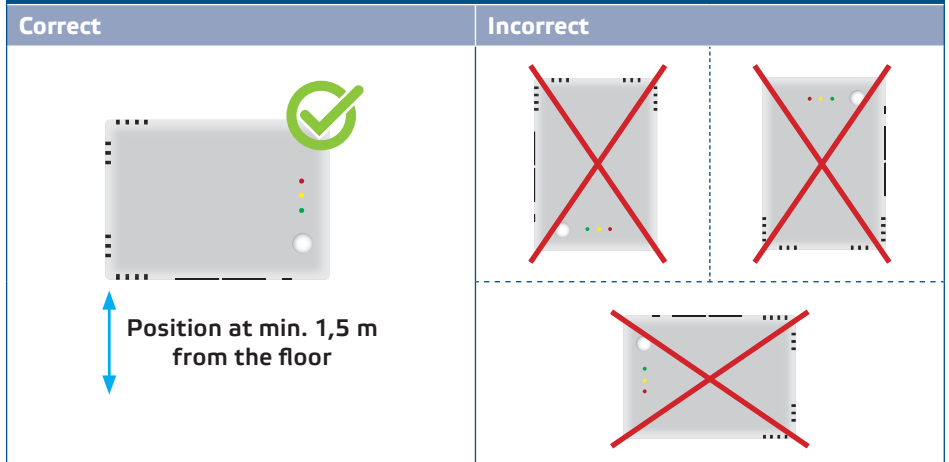
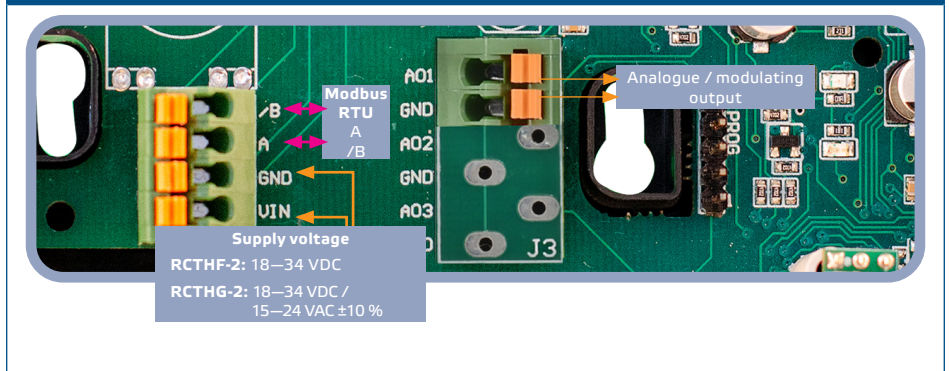

Fig. 3 Mounting position



4. Do the wiring according to the wiring diagram (see Fig. 4).

Fig. 4 Wiring



5. Put back the cover snap it in.
6. Switch on the mains supply.
7. Customise the factory settings to the desired ones via the 3SModbus software or Sensistant (if necessary). For the default factory setting refer to the product Modbus register map.

NOTE

For the complete Modbus register data, refer to the product Modbus Register Map, which is a separate document attached to the article code on the website and contains the registers list. Products with earlier firmware versions may not be compatible with this list.

Optional settings

To assure correct communication, the NBT needs to be activated in only two devices on the Modbus RTU network. If necessary, enable the NBT resistor via 3SModbus or Sensistant (Holding register 9).

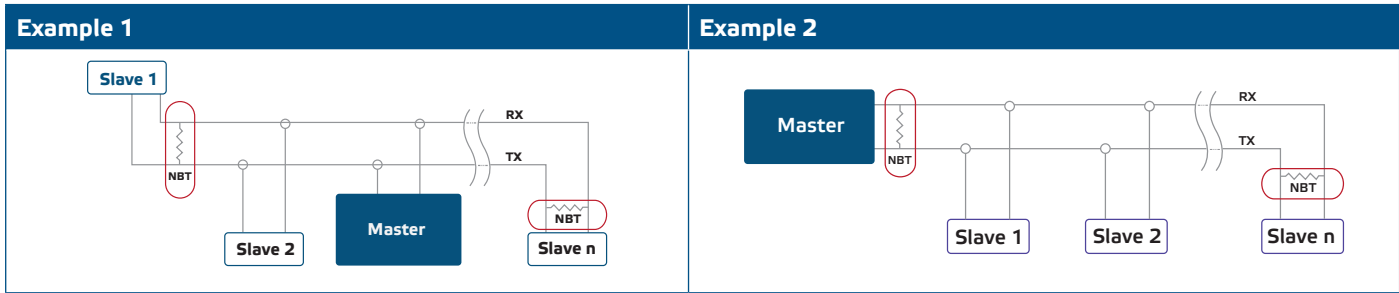

NOTE

On a Modbus RTU network, two bus terminators (NBTs) need to be activated.

OPERATING INSTRUCTIONS

Calibration procedure

All sensor elements are calibrated and tested in our factory. Recalibration is not necessary.

Firmware update

New functionalities and bug fixes are made available via a firmware update. In case your device does not have the latest firmware installed, it can be updated. SenteraWeb is the easiest way to update the unit firmware. In case you do not have an internet gateway available, the firmware can be updated via the 3SM boot application (part of the Sentera 3SMcenter software suite).

NOTE

Make sure the power supply does not get interrupted during "bootload" procedure.

LED indications

1. When the green LED is on, the measured value (temperature or relative humidity) is between the minimum and maximum alert range values (Fig. 5 - 1).
2. When the yellow LED is on, the measured value (temperature or relative humidity) is in the alert range (Fig. 5 - 2).
3. When the red LED is on, the measured value (temperature or relative humidity) is below the minimum measurement range value or above the maximum value. Blinking red LED indicates loss of communication with a sensor (Fig. 5 - 3).

Fig. 5 LED indications

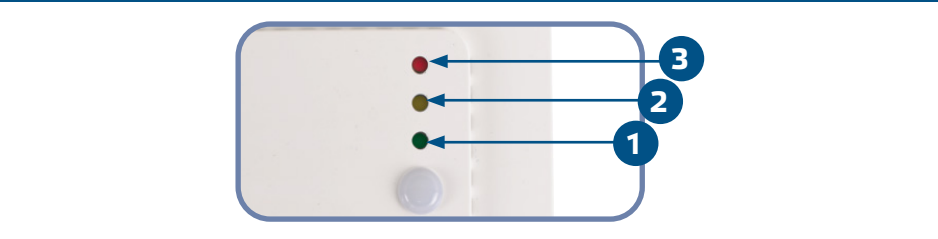

**NOTE**

*By default, the LED indication refers to temperature measurements. This can be changed to relative humidity values via Modbus Holding Register 79 (see **Table** Holding registers in the product Modbus Register Map).*

**NOTE**

LED intensity can be adjusted between 0 and 100 % with a step of 10 % according to the value set in Holding register 80.

Ambient light sensor

The measured light intensity in lux is available in Input Register 41. Additionally, an active and standby level can be defined in Holding registers 35 and 36. Input Register 42 indicates if the measured value is below standby level, above active level or in between both levels:

- Ambient light level < standby level: Input Register 42 indicates "Standby".
- Ambient light level > active level: Input Register 42 indicates "Active".
- Standby level < Ambient light level < Active level: Input Register 42 indicates "Low intensity".

VERIFICATION OF INSTALLATION INSTRUCTIONS

After switching on the power supply one of the LEDs lights up according to the status of the measured variable. If this is not the case, check the connections.

TRANSPORT AND STORAGE

Avoid shocks and extreme conditions; stock in original packing.

WARRANTY AND RESTRICTIONS

Two years from the delivery date against defects in manufacturing. Any modifications or alterations to the product after the date of publication relieve the manufacturer of any responsibilities. The manufacturer bears no responsibility for any misprints or mistakes in this data.

MAINTENANCE

In normal conditions this product is maintenance-free. If soiled, clean with a dry or damp cloth. In case of heavy pollution, clean with a non-aggressive product. In these circumstances the unit should be disconnected from the supply. Pay attention that no fluids enter the unit. Only reconnect it to the supply when it is completely dry.