

HPS-M-LP

DIFFERENTIAL
PRESSURE
TRANSMITTER

Mounting and operating instructions



Table of contents

SAFETY AND PRECAUTIONS	3
PRODUCT DESCRIPTION	4
ARTICLE CODES	4
INTENDED AREA OF USE	4
TECHNICAL DATA	4
STANDARDS	5
OPERATIONAL DIAGRAM	5
WIRING AND CONNECTIONS	5
MOUNTING INSTRUCTIONS IN STEPS	6
VERIFICATION OF THE INSTALLATION INSTRUCTIONS	8
OPERATING INSTRUCTIONS	8
TRANSPORT AND STORAGE	10
WARRANTY AND RESTRICTIONS	10
MAINTENANCE	10

SAFETY AND PRECAUTIONS



Read all the information, the datasheet, Modbus map, mounting and operating instructions and study the wiring and connection diagram before working with the product. For personal and equipment safety, and for optimum product performance, make sure you entirely understand the contents before installing, using, or maintaining this product.



For safety and licensing (CE) reasons, unauthorised conversion and /or modifications of the product are inadmissible.



The product should not be exposed to abnormal conditions, such as extreme temperatures, direct sunlight or vibrations. Long-term exposure to chemical vapours in high concentration can affect the product performance. Make sure the work environment is as dry as possible; avoid condensation.



All installations shall comply with local health and safety regulations and local electrical standards and approved codes. This product can only be installed by an engineer or a technician who has expert knowledge of the product and safety precautions.



Avoid contacts with energised electrical parts. Always disconnect the power supply before connecting, servicing or repairing the product.



Always verify that you apply appropriate power supply to the product and use appropriate wire size and characteristics. Make sure that all the screws and nuts are well tightened and fuses (if any) are fitted well.



Recycling of equipment and packaging should be taken into consideration and these should be disposed of in accordance with local and national legislation / regulations.



In case there are any questions that are not answered, please contact your technical support or consult a professional.

PRODUCT DESCRIPTION

The HPS-M--LP series are differential pressure transmitters (-125—125 Pa), which are equipped with a fully digital pressure transducer designed for a wide range of applications. Air velocity readout is available by connecting an external Pitot tube connection set. They are Power over Modbus supplied and parameters are accessible via Modbus RTU (3SModbus software or Sensistant).

ARTICLE CODES

Codes	Power supply	Connection	Maximum power consumption	Nominal power consumption	I _{max}	Operating range
HPS-M--LP	24 VDC, PoM	RJ45 connector on the PCB	1 W	0,75 W	40 mA	-125—125 Pa

INTENDED AREA OF USE

- Differential pressure, air velocity or volume flow measurement in HVAC applications
- Overpressurizing applications: clean rooms to avoid particle contamination or staircases for fire safety
- Underpressurizing applications: restaurant kitchens and biohazard laboratories
- Volume flow application: ensuring the minimum legal ventilation rate (m³/h) for buildings

TECHNICAL DATA

- RJ45 socket for Power over Modbus connection
- Built-in digital high resolution differential pressure sensor
- Air flow velocity can be measured via Modbus RTU (by using an external PSET-PTX-200 Pitot tube connection set)
- Minimum differential pressure range span: 5 Pa
- Minimum volume flow range span: 10 m³/h
- Minimum air velocity range span: 1 m/s
- Selectable response time: 0,1—10 s
- Implemented K-factor
- Differential pressure, volume flow or air velocity readout via Modbus RTU
- Selectable minimum and maximum operating ranges
- Modbus registers reset function (to factory pre-set values)
- Four LEDs for transmitter status indication
- Modbus RTU communication
- Sensor calibration procedure via tact switch
- Aluminium pressure connection nozzles
- Accuracy: ±2 % of the operating range
- Operating ambient conditions:
 - ▶ Temperature: -5—65 °C
 - ▶ Rel. humidity: < 95 % rH (non-condensing)
- Storage temperature: -20—70 °C

STANDARDS

- EMC Directive 2014/30/EC: CE
 - ▶ EN 61326-1:2013 Electrical equipment for measurement, control and laboratory use - EMC requirements - Part 1: General requirements
 - ▶ EN 61326-2-3:2013 Electrical equipment for measurement, control and laboratory use - EMC requirements - Part 2-3: Particular requirements - Test configuration, operational conditions and performance criteria for transducers with integrated or remote signal conditioning
- WEEE Directive 2012/19/EC
- RoHs Directive 2011/65/EC

OPERATIONAL DIAGRAM

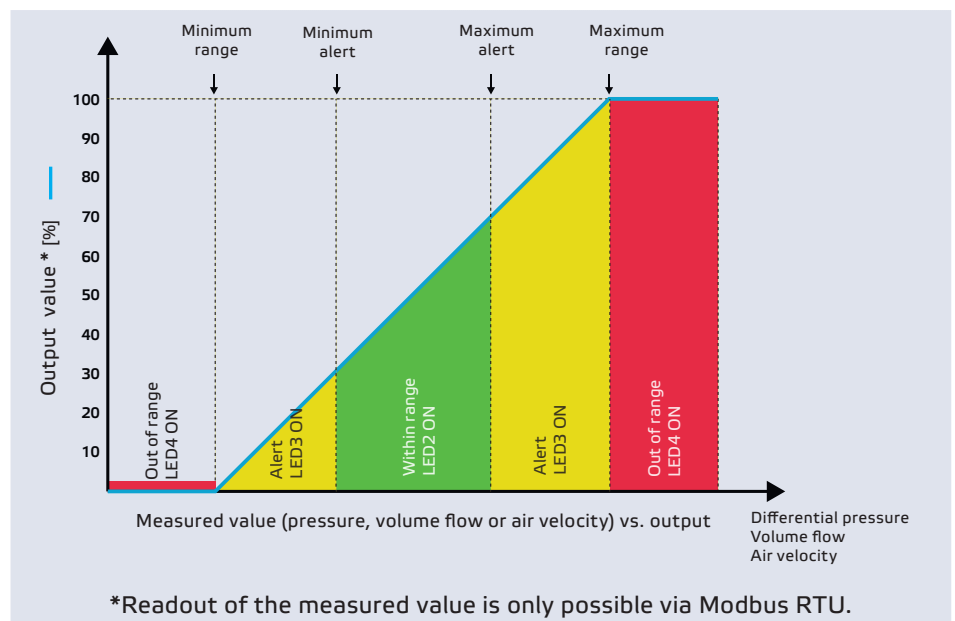

WIRING AND CONNECTIONS

RJ45 socket (Power over Modbus)		
Pin 1	24 VDC	Supply voltage
Pin 2		
Pin 3	A	Modbus RTU communication, signal A
Pin 4		
Pin 5	/B	Modbus RTU communication, signal /B
Pin 6		
Pin 7	GND	Ground, supply voltage
Pin 8		

MOUNTING INSTRUCTIONS IN STEPS

Before you start mounting the unit, read carefully **“Safety and Precautions”**. Choose a smooth surface for installation (a wall, panel, etc.) and follow these steps:

1. Unscrew the front cover of the enclosure to remove it.
2. Fix the enclosure onto the surface by means of suitable fasteners while adhering to the mounting dimensions shown in **Fig. 1** and the correct mounting position shown in **Fig. 2** below.

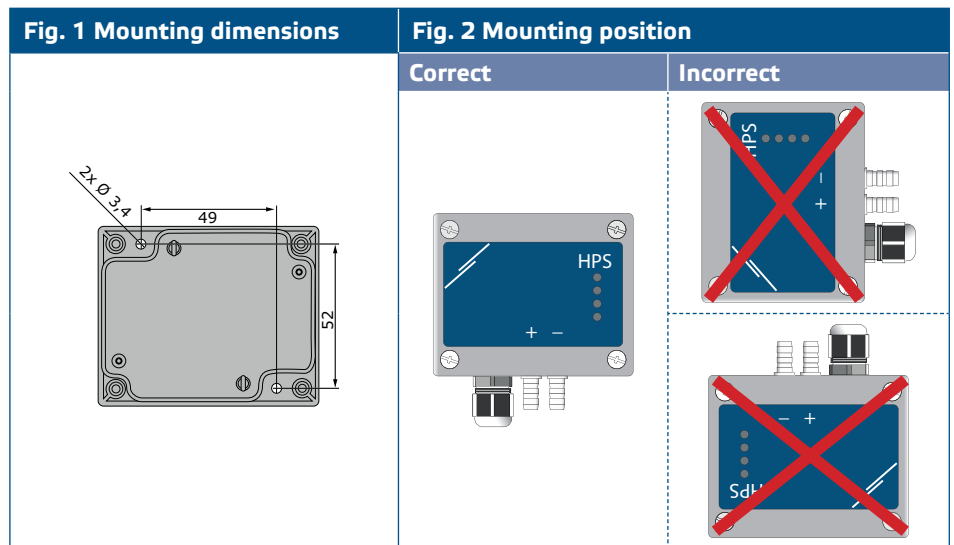

3. Insert the cable through the cable gland.
4. Crimp the RJ45 cable and plug it into the socket, see **Fig. 3** and section **“Wiring and connections”**.

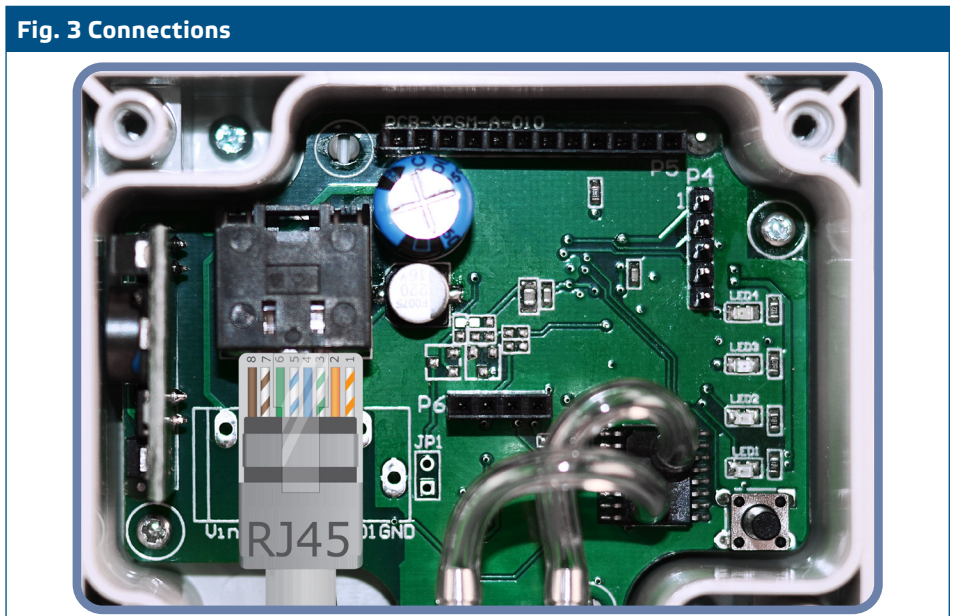

5. Connect the nozzles to the duct (see **Fig. 4**). Depending the application you must use a specific connection set to connect the nozzles of the unit to the duct:
 - 5.1 To control differential pressure, use PSET-QF or PSET-PVC set (pressure measurement is the unit default setting);
 - 5.2 To control volume flow, use PSET-PT Pitot tube connection set, PSET-QF or PSET-PVC connection set. If you use PSET-PT, you should enter the duct cross sectional area [cm²] in Modbus register 63. If you use PSET-QF or PSET-PVC, enter the K-factor of the fan (provided by the fan /motor manufacturer) in Modbus holding register 62. In case the K-factor is not known, volume flow is calculated from a duct cross sectional area (holding register 63) multiplied by air velocity (Pitot air velocity (holding register 64) should be enabled and Pitot tube connected).
 - 5.3 To control air velocity, use PSET-PT set and enable Pitot tube air velocity via holding register 64. In this case the K-factor of the fan has to be 0.

Fig. 4 Connecting with accessories

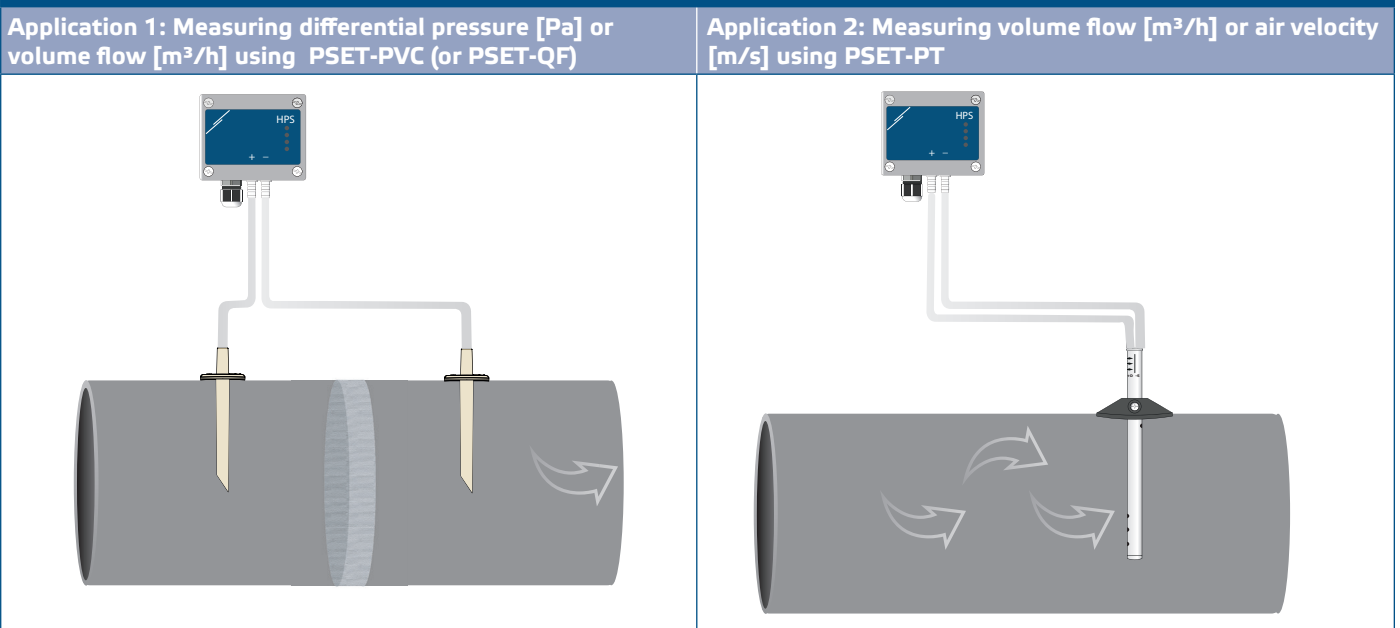

6. Switch on the power supply.

NOTE

For sensor calibration and Modbus registers reset procedures, refer to section "Operating instructions".

Optional settings

To assure correct communication, the NBT needs to be activated in only two devices on the Modbus RTU network. If necessary, enable the NBT resistor via 3SModbus or Sensistant (Holding register 9).

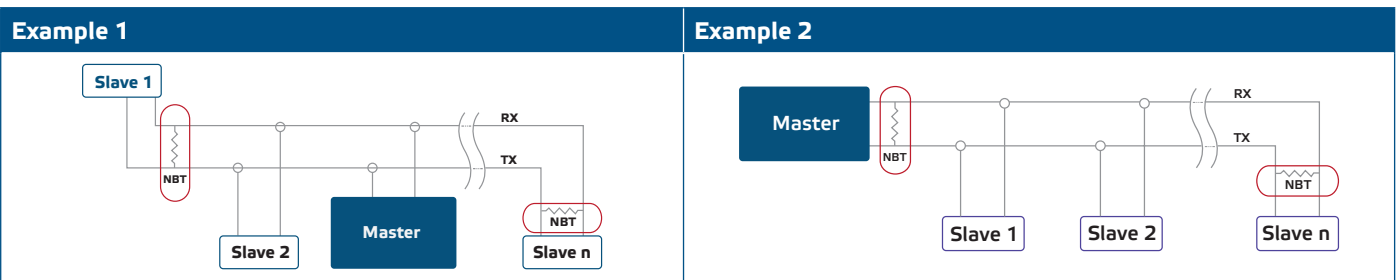

NOTE

On a Modbus RTU network, two bus terminators (NBTs) need to be activated.

- Put back the front cover and secure it with the screws.
- Customise the factory settings to the desired ones via the 3SModbus software or the Sensistant configurator. For the default factory settings, see *Modbus register map*.

NOTE

For the complete Modbus register data, refer to the product Modbus Register Map, which is a separate document attached to the article code on the website and contains the registers list. Products with earlier firmware versions may not be compatible with this list.

VERIFICATION OF THE INSTALLATION INSTRUCTIONS

A continuous green LED1 indication as shown in **Fig. 5 Power / Modbus communication indication** means the unit is powered. If LED1 is not on, check the connections again.

A blinking green LED1 indication as shown in **Fig. 5 Power / Modbus communication indication** means the unit has detected a Modbus network. If LED1 does not blink, check the connections again.

NOTE

For more information, refer to the product datasheet - Settings.

Fig. 5 Power / Modbus communication indication



ATTENTION

The status of the LEDs can be checked only when the unit is energised. Take the relevant safety measures!

ATTENTION

LED intensity can be adjusted between 0 and 100 % with a step of 10 % according to the value set in Holding register 95.

OPERATING INSTRUCTIONS

NOTE

For detailed information and settings, refer to the product Modbus register map, which is attached to the article code on our website.

Calibration procedure:

1. Disconnect the nozzles and make sure they are not clogged.
2. There are two options for starting the calibration process:
Either write "1" in holding register 70 or press button SW1 for 4 seconds until the green LED2 and yellow LED3 on the printed circuit board blink twice and release it immediately. If you hold SW1 for too long you will reset the Modbus registers! (see Fig. 6).
3. After 2 seconds the green LED2 and yellow LED3 will blink twice once again to indicate that the calibration procedure has finished (see Fig. 7 Calibration Indication).

ATTENTION

Make sure that the nozzles are disconnected and unobstructed.

Reset of Modbus registers procedure:

1. Press tact switch SW1 for 4 seconds until the green LED2 and yellow LED3 on the printed circuit board blink twice and hold the switch until both LEDs blink again three times.
2. The Modbus registers are reset to their default values (factory pre-set).

Fig. 6 Sensor calibration and Modbus register reset

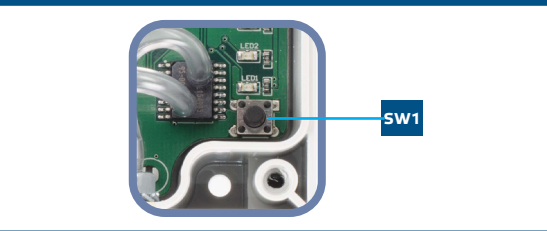

Fig. 7 Calibration indication



NOTE

Press and hold the tact switch until both LEDs on the PCB blink twice and hold it until both LEDs blink again three times. If the tact switch is released before both LEDs blink again three times, the sensor will have carried out a calibration procedure instead of Modbus registers reset procedure.

Communication holding registers reset procedure:

1. Put the jumper onto pins 1 and 2 of the P4 connector for more than 20 s while the device is powered (see Fig. 8).

Fig. 8 Modbus holding register reset jumper

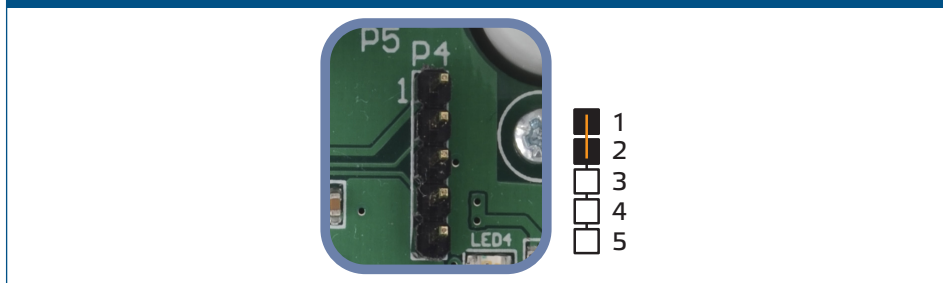

2. Modbus communication holding registers from 1 to 3 will be reset to the default values.
3. Remove the jumper.

ATTENTION

Correct reading of air velocity is only possible if it is enabled by holding register 64 (Pitot air velocity) and a transmitter is connected to the appropriate Pitot tube connection set (PSET-PTX-200).

LED indications (See Fig. 9):

1. When the green LED1 is on, the power supply is adequate and Modbus RTU communication is active.
2. When the green LED2 is on, the measured value (pressure, volume or air velocity) is between the minimum and maximum alert range.
3. When the yellow LED3 is on, the measured value (pressure, volume or air velocity) is below the minimum alert range or above the maximum alert range.
4. When the red LED4 is on, the measured value (pressure, volume or air velocity) is below the minimum measurement range or above the maximum.

Fig. 9 LED indications

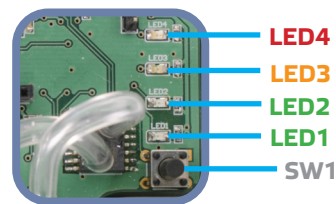

5. Sensor element failure indication:
In case of failure of sensor element or loss of communication with it, the red LED4 blinks. See Fig. 10.

Fig. 10 Sensor element error

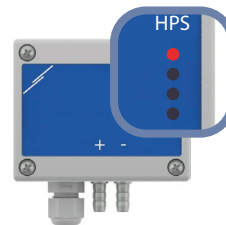

TRANSPORT AND STORAGE

Avoid shocks and extreme conditions; stock in original packing.

WARRANTY AND RESTRICTIONS

Two years from the delivery date against defects in manufacturing. Any modifications or alterations to the product after the date of publication relieve the manufacturer of any responsibilities. The manufacturer bears no responsibility for any misprints or mistakes in this data.

MAINTENANCE

In normal conditions this product is maintenance-free. If soiled, clean with a dry or damp cloth. In case of heavy pollution, clean with a non-aggressive product. In these circumstances the unit should be disconnected from the supply. Pay attention that no fluids enter the unit. Only reconnect it to the supply when it is completely dry.