

DSMHM-2R | MULTIFUNCTIONAL DUCT TRANSMITTER WITH CORROSION PROTECTION

Mounting and operating instructions

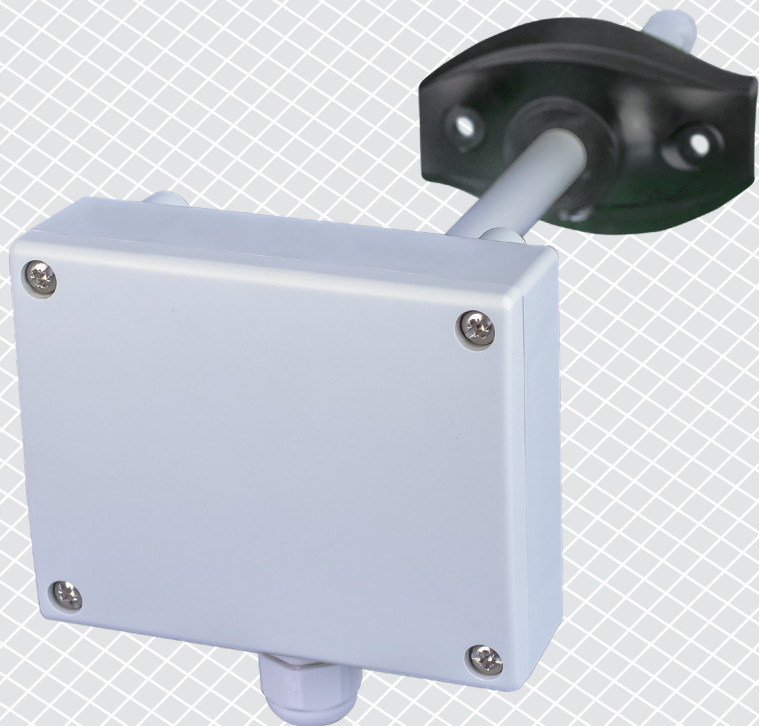

Table of contents

SAFETY AND PRECAUTIONS	3
PRODUCT DESCRIPTION	4
ARTICLE CODES	4
INTENDED AREA OF USE	4
TECHNICAL DATA	4
STANDARDS	4
OPERATIONAL DIAGRAMS	5
WIRING AND CONNECTIONS	5
MOUNTING & OPERATING INSTRUCTIONS IN STEPS	5
OPERATING INSTRUCTIONS	8
VERIFICATION OF INSTALLATION INSTRUCTIONS	9
TRANSPORT AND STORAGE	9
WARRANTY AND RESTRICTIONS	9
MAINTENANCE	9

SAFETY AND PRECAUTIONS



Read all the information, the datasheet, Modbus map, mounting and operating instructions and study the wiring and connection diagram before working with the product. For personal and equipment safety, and for optimum product performance, make sure you entirely understand the contents before installing, using, or maintaining this product.



For safety and licensing (CE) reasons, unauthorised conversion and /or modifications of the product are inadmissible.



The product should not be exposed to abnormal conditions, such as extreme temperatures, direct sunlight or vibrations. Long-term exposure to chemical vapours in high concentration can affect the product performance. Make sure the work environment is as dry as possible; avoid condensation.



All installations shall comply with local health and safety regulations and local electrical standards and approved codes. This product can only be installed by an engineer or a technician who has expert knowledge of the product and safety precautions.



Avoid contacts with energised electrical parts. Always disconnect the power supply before connecting, servicing or repairing the product.



Always verify that you apply appropriate power supply to the product and use appropriate wire size and characteristics. Make sure that all the screws and nuts are well tightened and fuses (if any) are fitted well.



Recycling of equipment and packaging should be taken into consideration and these should be disposed of in accordance with local and national legislation / regulations.



In case there are any questions that are not answered, please contact your technical support or consult a professional.

PRODUCT DESCRIPTION

The DSMHM-2R are multifunctional duct transmitters which measure temperature, relative humidity and CO₂ concentration. They are treated with anti-corrosion and ammonia resistant coating that makes them suitable for applications in the agriculture and horticulture industry or other harsh environments. Based on the temperature and relative humidity measurements, the dew point is calculated. They are Power over Modbus supplied and all parameters are accessible via Modbus RTU.

ARTICLE CODES

Code	Supply	Connection
DSMHM-2R	Power over Modbus, 24 VDC	RJ45

INTENDED AREA OF USE

- Monitoring temperature, relative humidity and CO₂ level in air ducts
- Suitable for harsh environments. Application field: greenhouses, livestock breeding farms, mushroom growing houses, etc.

TECHNICAL DATA

- Selectable temperature range: -30—70 °C
- Selectable relative humidity range: 0—100 %
- Selectable CO₂ range: 0—10.000 ppm
- Accuracy: ±0,4 °C (range -30—70 °C); ±3 % rH (range 0—100% rH); ±30 ppm CO₂ (range 400—5.000 ppm)
- Maximum power consumption: 1,08 W
- Nominal power consumption in normal operation: 0,81 W
- I_{max}: 45 mA
- Replaceable CO₂ sensor element
- Minimum airflow velocity required: 1 m/s
- Enclosure and probe material:
 - ▶ ASA, grey (RAL9002)
- Protection standard: enclosure: IP54, probe: IP20
- Typical field of use:
 - ▶ temperature: -30—70 °C
 - ▶ rel. humidity: 0—100 % rH, (non-condensing)
 - ▶ CO₂: 400—5.000 ppm
- Storage temperature: -10—60 °C

STANDARDS

- EMC Directive 2014/30/EC: 
 - ▶ EN 61326-1:2013 Electrical equipment for measurement, control and laboratory use - EMC requirements - Part 1: General requirements
 - ▶ EN 61326-2-3:2013 Electrical equipment for measurement, control and laboratory use - EMC requirements - Part 2-3: Particular requirements - Test configuration, operational conditions and performance criteria for transducers with integrated or remote signal conditioning
- High protective conformal coating
 - ▶ MIL-I-46058C qualified
 - ▶ IPC-CC-830
- RoHs Directive 2011/65/EC and EPA 33/50 compliant

OPERATIONAL DIAGRAMS

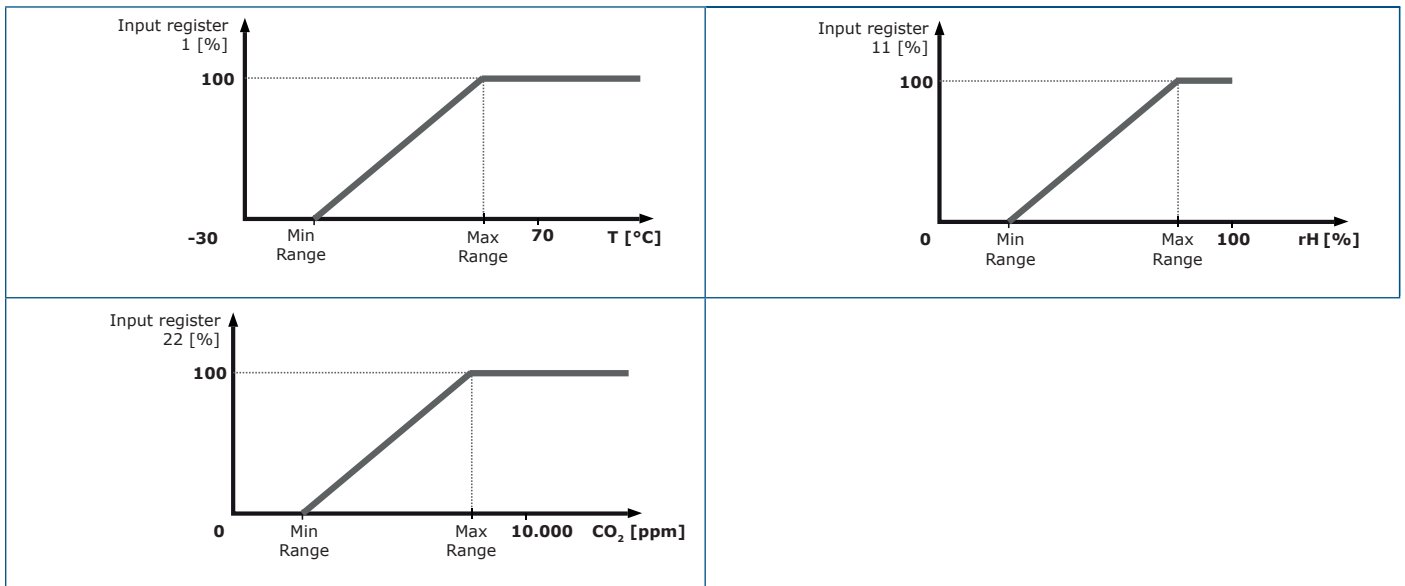

WIRING AND CONNECTIONS

RJ45 socket (Power over Modbus)		
Pin 1	24 VDC	Supply voltage
Pin 2		
Pin 3	A	Modbus RTU communication, signal A
Pin 4		
Pin 5	/B	Modbus RTU communication, signal /B
Pin 6		
Pin 7	GND	Ground, supply voltage
Pin 8		

MOUNTING & OPERATING INSTRUCTIONS IN STEPS

Before you start mounting the unit read carefully **“Safety and Precautions”**.

Follow these steps:

1. When preparing to mount the unit, bear in mind that the probe opening must be positioned in the centre of the duct. Always use the flange to install the sensor on round ducts. It is possible to install the sensor without the flange on rectangular ducts (if necessary), see **Fig. 1** and **Fig. 2** below.

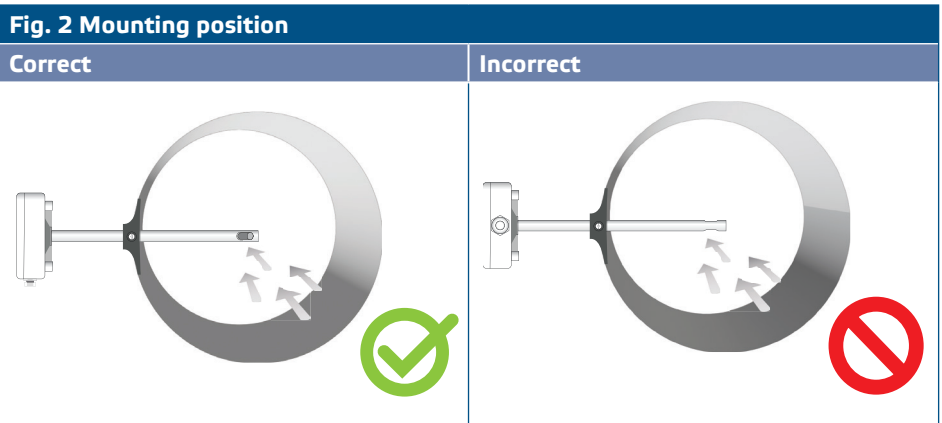
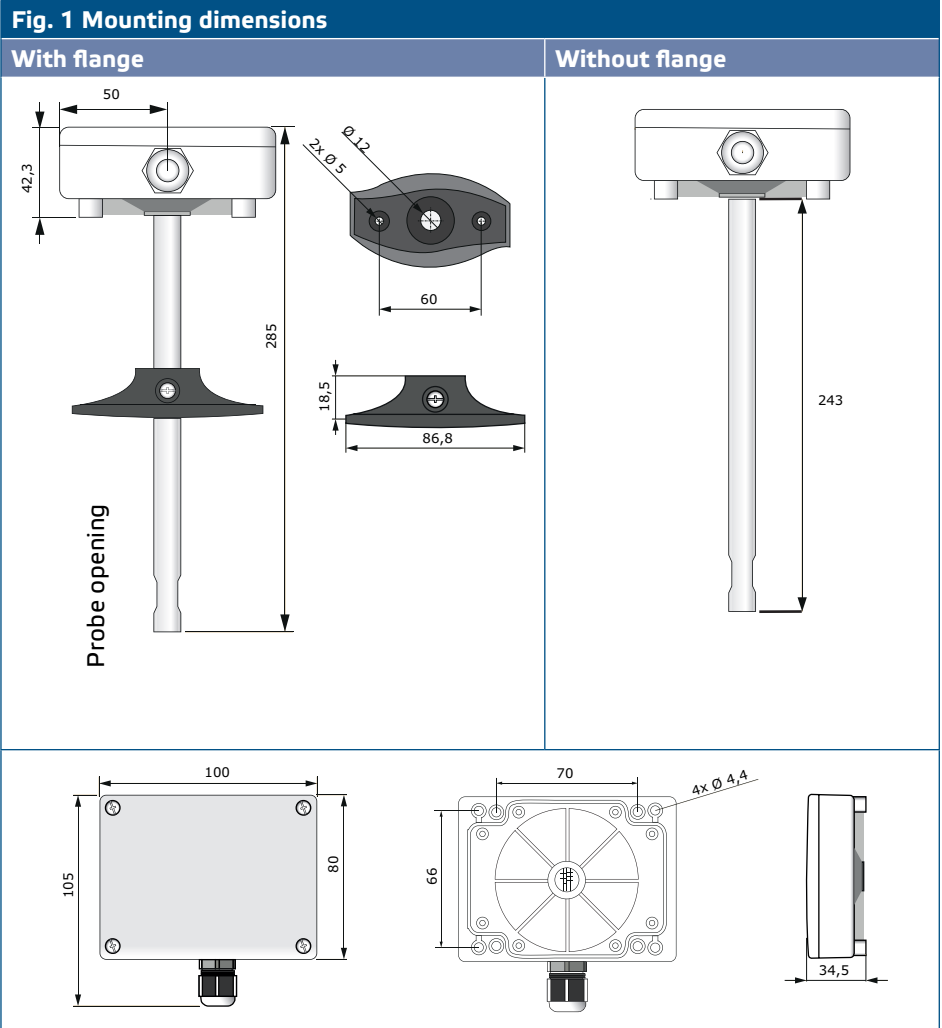

2. Having selected the appropriate mounting location, proceed with the following steps:
 - 2.1 Drill a tight-sealing $\text{Ø } 13 \text{ mm}$ hole into the duct.
 - 2.2 Fix the flange onto the duct outer surface using the self-drilling screws delivered with the unit. If you do not intend to use the flange, insert the probe and fix the enclosure onto the duct. Mind the airflow direction (see **Fig. 2** and **Fig. 3**).

Fig. 3 Mounting requirements

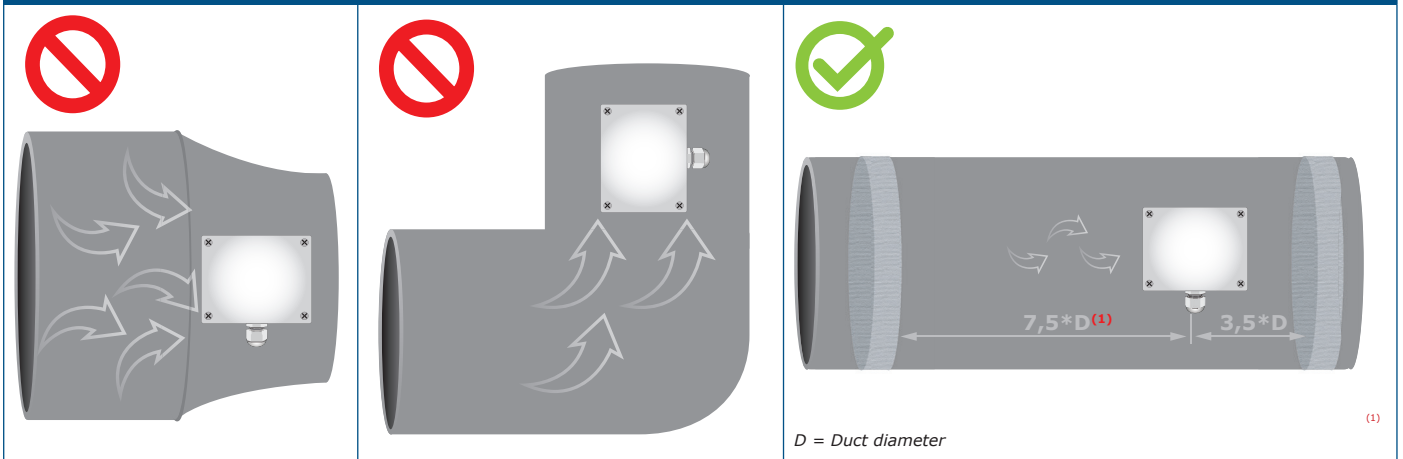

ATTENTION

Installation requirements: The unit must not be installed in turbulent air zones. Ensure sufficiently long settling zones upstream and downstream of the tapping point. A settling zone consists of a straight section of pipe or duct with no obstructions. Avoid installation near filters, cooling coils, fans, etc. The sensor will achieve the optimal result when the measurement is taken at least 7,5 duct diameters downstream and at least 3 duct diameters upstream from any turns or flow obstructions.

ATTENTION

Installation of the unit near high EMI-emitting devices may lead to faulty measurements. Use shielded wiring in areas with high EMI.

ATTENTION

Keep at least 15 cm distance between the sensor lines and the 230 VAC power lines.

- 2.3 Install the probe at the desired depth and; in case you use the flange, fix it via the plastic white screw in the flexible flange.
- 2.4 Unscrew the cover of the unit to remove it and insert the connecting cables through the cable gland of the unit.
- 2.5 Do the wiring according to the wiring diagram (see Fig. 4) adhering to the information from section "Wiring and connections".

Fig. 4 Wiring and connections

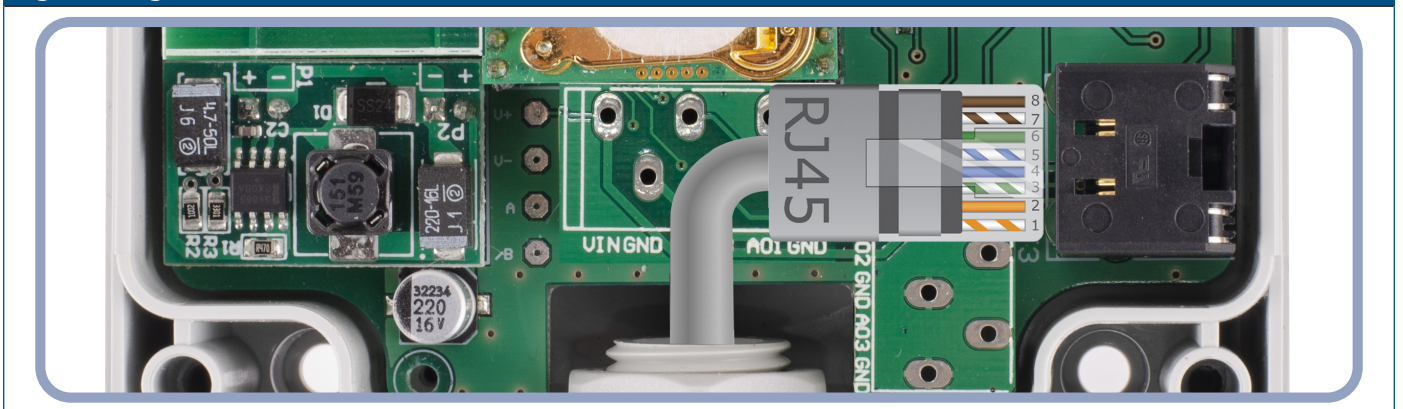

- 3. Close the enclosure and fix it with the screws. Tighten the cable gland to retain the IP rating of the enclosure.
- 4. Switch on the power supply.
- 5. Customise the factory settings to the desired ones via the 3SModbus software or Sensistant (if necessary). For the default factory setting, see the Modbus register map.

NOTE

For the complete Modbus register data, refer to the product Modbus Register Map, which is a separate document attached to the article code on the website and contains the registers list. Products with earlier firmware versions may not be compatible with this list.

Optional settings

To assure correct communication, the NBT needs to be activated in only two devices on the Modbus RTU network. If necessary, enable the NBT resistor via 3SModbus or Sensistant (Holding register 9).

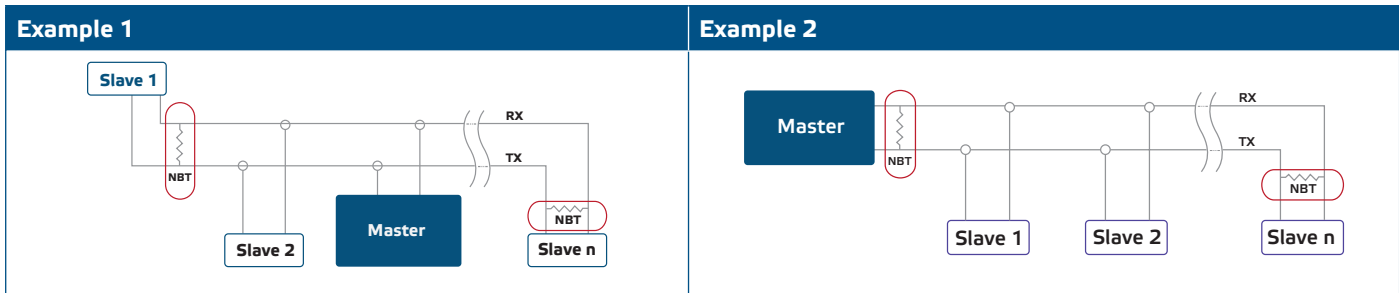

NOTE

On a Modbus RTU network, two bus terminators (NBTs) need to be activated.

CAUTION

Do not expose to direct sunlight!

OPERATING INSTRUCTIONS

NOTE

For detailed information and settings, refer to the product Modbus register map, which is attached to the article code on our website.

Calibration procedure:

Sensor calibration is not necessary. In the unlikely event of CO₂ sensor element failure, this component can be replaced. All sensor elements are calibrated and tested in our factory.

Bootloader

Thanks to the bootloader functionality, the unit firmware can be updated via Modbus RTU communication. With 3SM boot Application (part of 3SM center software suite), 'boot mode' is automatically activated and the firmware can be updated.

NOTE

Make sure the power supply does not get interrupted during "bootload" procedure, otherwise you risk losing unsaved data.

VERIFICATION OF INSTALLATION INSTRUCTIONS

If your unit does not function as expected, please check the connections.

TRANSPORT AND STORAGE

Avoid shocks and extreme conditions; stock in original packing.

WARRANTY AND RESTRICTIONS

Two years from the delivery date against defects in manufacturing. Any modifications or alterations to the product after the date of publication relieve the manufacturer of any responsibilities. The manufacturer bears no responsibility for any misprints or mistakes in this data.

MAINTENANCE

In normal conditions this product is maintenance-free. If soiled, clean with a dry or damp cloth. In case of heavy pollution, clean with a non-aggressive product. In these circumstances the unit should be disconnected from the supply. Pay attention that no fluids enter the unit. Only reconnect it to the supply when it is completely dry.