

DPSP -2 | DIFFERENTIAL PRESSURE CONTROLLER FOR FANS

Mounting and operating instructions



Table of contents

SAFETY AND PRECAUTIONS	3
PRODUCT DESCRIPTION	4
ARTICLE CODES	4
INTENDED AREA OF USE	4
TECHNICAL DATA	4
STANDARDS	5
OPERATIONAL DIAGRAM	5
WIRING AND CONNECTIONS	6
MOUNTING INSTRUCTIONS IN STEPS	6
OPERATING INSTRUCTIONS	9
VERIFICATION OF THE INSTALLATION INSTRUCTIONS	12
TRANSPORT AND STORAGE	13
WARRANTY AND RESTRICTIONS	13
MAINTENANCE	13

SAFETY AND PRECAUTIONS



Read all the information, the datasheet, the Modbus register map, the mounting and operating instructions and study the wiring and connection diagram before working with the product. For personal and equipment safety, and for optimum product performance, make sure you entirely understand the contents before installing, using, or maintaining this product.



For safety and licensing (CE) reasons, unauthorised conversion and /or modifications of the product are inadmissible.



The product should not be exposed to abnormal conditions, such as: extreme temperatures, direct sunlight or vibrations. Long-term exposure to chemical vapours in high concentration can affect the product performance. Make sure the work environment is as dry as possible; avoid condensation.



All installations shall comply with local health and safety regulations and local electrical standards and approved codes. This product can only be installed by an engineer or a technician who has expert knowledge of the product and safety precautions.



Avoid contacts with energised electrical parts. Always disconnect the power supply before connecting, servicing or repairing the product.



Always verify that you apply appropriate power supply to the product and use appropriate wire size and characteristics. Make sure that all the screws and nuts are well tightened and fuses (if any) are fitted well.



Recycling of equipment and packaging should be taken into consideration and these should be disposed of in accordance with local and national legislation / regulations.



In case there are any questions that are not answered, please contact your technical support or consult a professional.

PRODUCT DESCRIPTION

The DPSP -2 series are high resolution differential pressure controllers. The integrated PI control with anti-windup function offers the possibility to directly control EC motors / fans. They are equipped with a fully digital state-of-the-art pressure transducer designed for a wide range of applications. Zero point calibration and Modbus registers reset can be executed via a tactile switch. They also feature integrated K-factor and an analogue / modulating output (0–10 VDC / 0–20 mA / 0–100 % PWM). All parameters are accessible via Modbus RTU (3SModbus software or Sensistant).

ARTICLE CODES

Codes	Power supply	I _{max}	Operating range
DPSPF-1K0-2	18–34 VDC	100 mA	0–1.000 Pa
DPSPF-2K0-2			0–2.000 Pa
DPSPF-4K0-2			0–4.000 Pa
DPSPF-10K-2			0–10.000 Pa
DPSPG-1K0-2	18–34 VDC	95 mA	0–1.000 Pa
DPSPG-2K0-2			0–2.000 Pa
DPSPG-4K0-2	15–24 VAC ±10 %	220 mA	0–4.000 Pa
DPSPG-10K-2			0–10.000 Pa

INTENDED AREA OF USE

- Differential pressure, air velocity or volume flow based control of fans
- Overpressurizing applications: clean rooms to avoid particle contamination or staircases for fire safety
- Underpressurizing applications: restaurant kitchens and biohazard laboratories
- Volume flow application: ensuring the minimum legal ventilation rate (m³/h) for buildings

TECHNICAL DATA

- 4-digit 7-segment LED display for indicating differential pressure or air volume flow
- Built-in digital high resolution differential pressure sensor
- Air velocity can be measured via Modbus RTU (by using an external PSET-PTX-200 Pitot tube connection set)
- Selectable analogue / digital output: 0–10 VDC / 0–20 mA / PWM (open collector type):
 - ▶ 0–10 VDC mode: $R_L \geq 50 \text{ k}\Omega$
 - ▶ 0–20 mA mode: $R_L \leq 500 \Omega$
 - ▶ PWM mode: PWM Frequency: 1 kHz, $R_L \geq 50 \text{ k}\Omega$
- Minimum differential pressure span: 5 Pa
- Minimum volume flow range span: 10 m³/h
- Minimum air velocity range span: 1 m/s
- Selectable response time: 0,1–10 s
- Implemented K-factor
- Selectable internal voltage source for PWM output: 3,3 or 12 VDC
- Differential pressure, air volume or air velocity readout via Modbus RTU
- Selectable minimum and maximum operating ranges
- Modbus registers reset function (to factory pre-set values)
- Four LEDs for status indication
- Modbus RTU communication
- Sensor calibration procedure via tact switch
- Aluminium pressure connection nozzles

- Accuracy: $\pm 2\%$ of the operating range
- Operating ambient conditions:
 - ▶ Temperature: $-5\text{--}65\text{ }^{\circ}\text{C}$
 - ▶ Rel. humidity: $< 95\%$ rH (non-condensing)
- Storage temperature: $-20\text{--}70\text{ }^{\circ}\text{C}$

STANDARDS

- EMC Directive 2014/30/EC: CE
 - ▶ EN 61326-1:2013 Electrical equipment for measurement, control and laboratory use - EMC requirements - Part 1: General requirements
 - ▶ EN 61326-2-3:2013 Electrical equipment for measurement, control and laboratory use - EMC requirements - Part 2-3: Particular requirements - Test configuration, operational conditions and performance criteria for transducers with integrated or remote signal conditioning
- WEEE Directive 2012/19/EC
- RoHs Directive 2011/65/EC

OPERATIONAL DIAGRAM

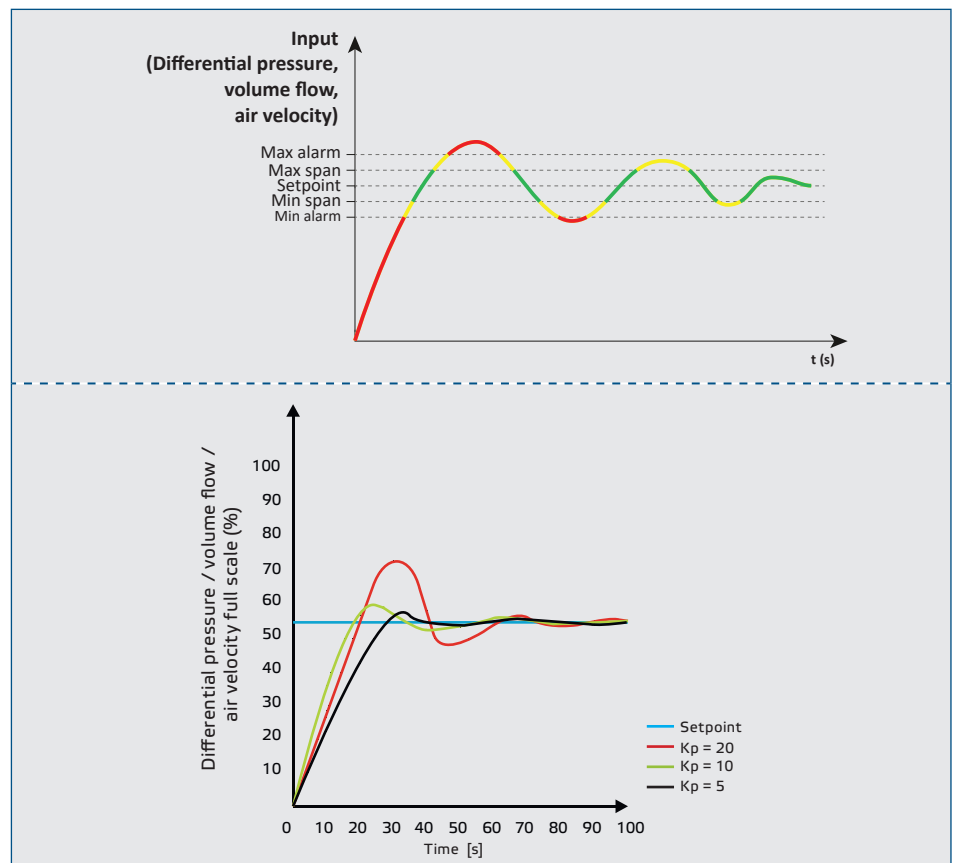

NOTE

The minimum output value can be adjusted in the range between 10 to 50 %. A minimum amount of air flow is required to control a fan in a stable way. When the operation mode is 'stop', the fan is stopped and there is no pressure in the control application

WIRING AND CONNECTIONS

Article type	DPSPF	DPSPG	
Vin	18–34 VDC	18–34 VDC	13–26 VAC
	Ground	Common ground	AC ~
GND	Ground / AC ~		
A	Modbus RTU (RS485), signal A		
/B	Modbus RTU (RS485), signal /B		
AO1	Analogue / modulating output (0–10 VDC / 0–20 mA / PWM)		
GND	Ground AO1	Common ground	
Connections	Cable cross section	1,5 mm ²	

⚠ ATTENTION

The -F version of the product is not suited for 3-wire connection. It has separate grounds for power supply and analogue output. Connecting both grounds together might result in incorrect measurements. Minimum 4 wires are required to connect -F type sensors.

The -G version is intended for 3-wire connection and features a ‘common ground’. This means that the ground of the analogue output is internally connected with the ground of the power supply. For this reason, -G and -F types cannot be used together on the same network. Never connect the common ground of -G type articles to other devices powered by a DC voltage. Doing so might cause permanent damage to the connected devices.

MOUNTING INSTRUCTIONS IN STEPS

Before you start mounting the unit, read carefully **“Safety and Precautions”**. Choose a smooth surface for installation (a wall, panel, etc.) and follow these steps:

1. Unscrew the front cover of the enclosure to remove it.
2. Fix the enclosure onto the surface by means of suitable fasteners while adhering to the mounting dimensions shown in **Fig. 1** and the correct mounting position shown in **Fig. 2** below.

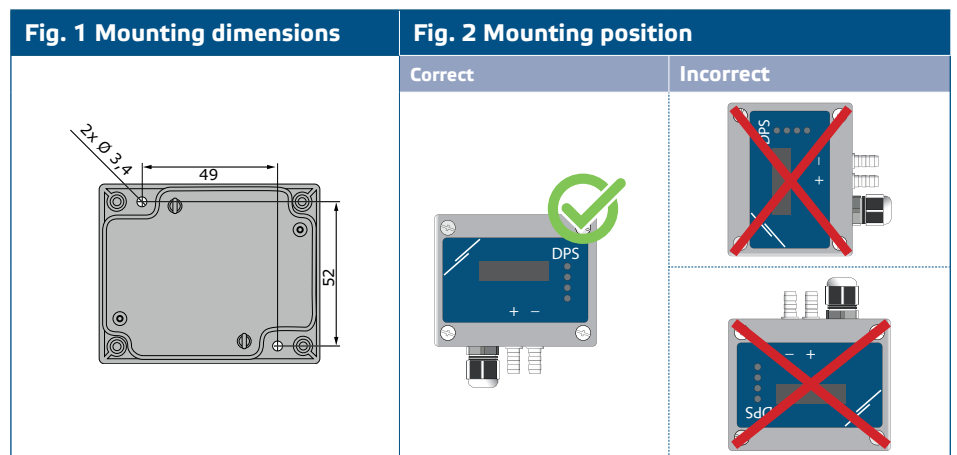

3. Insert the cable into the cable gland.
4. Connect as shown in **Fig. 3 Connections** adhering to the information in section "Wiring and connections".

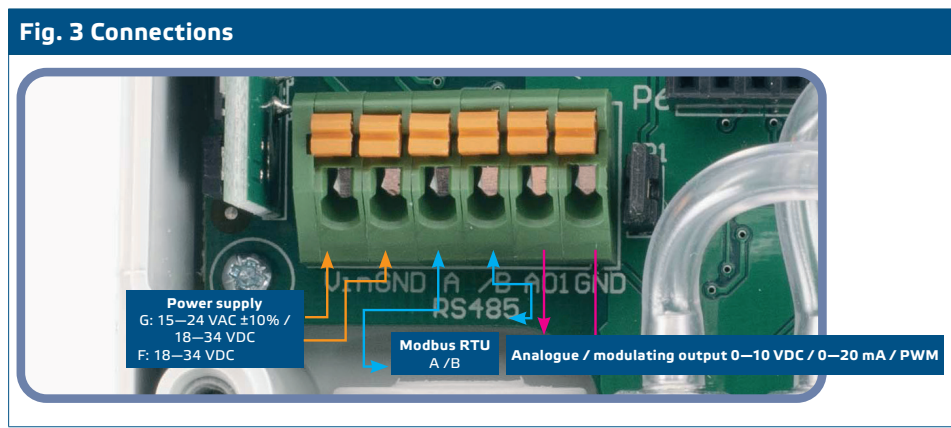

5. Connect the nozzles to the duct (see **Fig. 4**). Depending the application you must use a specific connection set to connect the nozzles of the unit to the duct:
 - 5.1 To control differential pressure, use PSET-QF or PSET-PVC set (pressure measurement is the unit default setting);
 - 5.2 To control volume flow, use PSET-PT Pitot tube connection set, PSET-QF or PSET-PVC connection set. If you use PSET-PT, you should enter the duct cross sectional area [cm²] in Modbus register 63. If you use PSET-QF or PSET-PVC, enter the K-factor of the fan (provided by the fan /motor manufacturer) in Modbus holding register 62. In case the K-factor is not known, volume flow is calculated from a duct cross sectional area (holding register 63) multiplied by air velocity (Pitot air velocity (holding register 64) should be enabled and Pitot tube connected).
 - 5.3 To control air velocity, use PSET-PT set and enable Pitot tube air velocity via holding register 64. In this case the K-factor of the fan has to be 0.

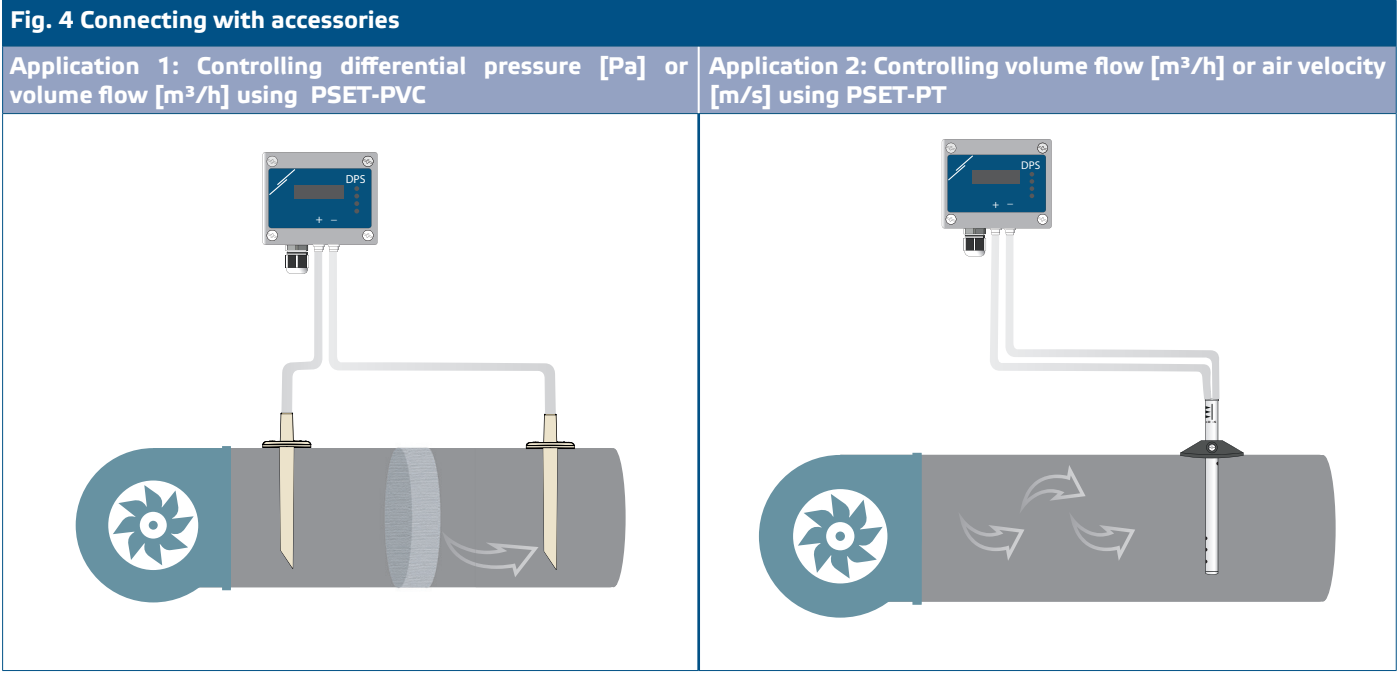

6. Switch on the power supply.

NOTE

For sensor calibration and Modbus registers reset procedures, refer to section "Operating instructions".

[back to the table of contents](#)

PWM voltage selection:

When the internal pull-up resistor (JP1) is connected, the voltage source is set via Modbus holding register 54, i.e. 3,3 VDC or 12 VDC. See **Fig. 5** *Pull-up resistor jumper connected*.

Fig. 5 Pull-up resistor jumper connected

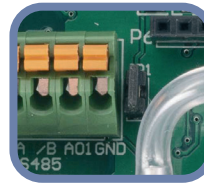

- When JP1 is not connected, the output type is Open collector. See **Fig. 6**. An external pull-up resistor must be used and the analogue output (AO1) must be assigned as PWM output (via holding register 54 - see the *Modbus Map*).

Fig. 6 PWM (Open collector) connection (JP1 disconnected)

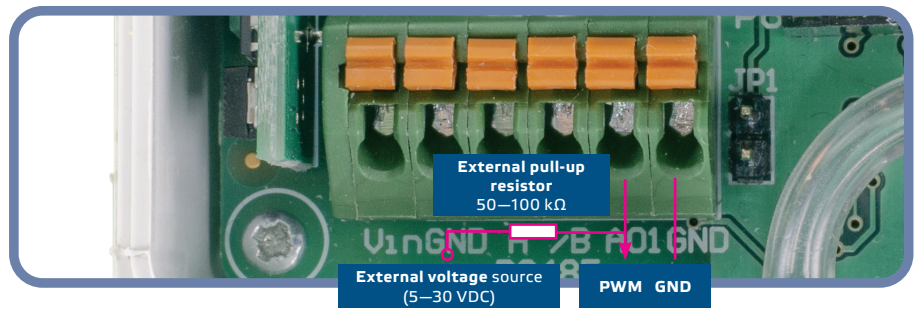

Optional settings

To assure correct communication, the NBT needs to be activated in only two devices on the Modbus RTU network. If necessary, enable the NBT resistor via 3SModbus or Sensistant (*Holding register 9*).

Example 1

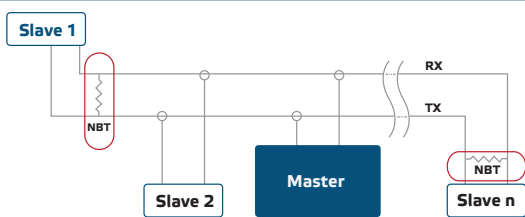

Example 2

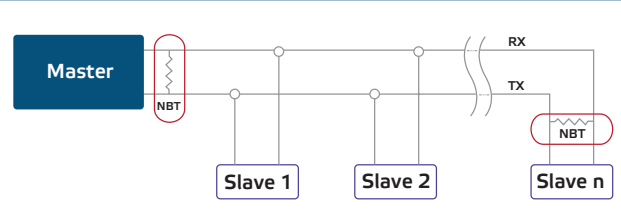

NOTE

On a Modbus RTU network, two bus terminators (NBTs) need to be activated.

- Put back the front cover and secure it with the screws.
- Customise the factory settings to the desired ones via the 3SModbus software or the Sensistant configurator. For the default factory settings, see *Modbus register map*.



NOTE

For the complete Modbus register data, refer to the product Modbus Register Map, which is a separate document attached to the article code on the website and contains the registers list. Products with earlier firmware versions may not be compatible with this list.

OPERATING INSTRUCTIONS



NOTE

For detailed information and settings, refer to the product Modbus register map, which is attached to the article code on our website.

Calibration procedure:

1. Disconnect the nozzles and make sure they are not clogged.
2. There are two options for starting the calibration process:
Either write "1" in holding register 70 or press button SW1 for 4 seconds until the green LED2 and yellow LED3 on the printed circuit board blink twice and release it (see Fig. 7 Sensor calibration and Modbus register reset tact switch and indication).
3. "C" for calibration will appear on the display (see Fig. 8 a Calibration Indication).
4. After 2 seconds the green LED2 and yellow LED3 will blink twice once again to indicate that the calibration procedure has finished.



ATTENTION

Make sure that the nozzles are disconnected and unobstructed.

Reset of Modbus registers procedure:

1. Press tact switch SW1 for 4 seconds until the green LED2 and yellow LED3 on the printed circuit board blink twice and hold the switch until both LEDs blink again three times (see Fig. 7 Sensor calibration and Modbus register reset tact switch and indication).
2. The Modbus registers are reset to their default values (factory pre-set).
3. During the Modbus reset procedure the display will indicate "H" (See Fig. 8 b Modbus reset indication).

Fig. 7 Sensor calibration and Modbus register reset tact switch and indications

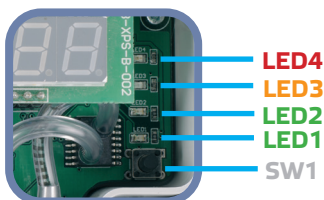

LED4
LED3
LED2
LED1
SW1

Fig. 8 Calibration & Modbus reset indication

8 a Calibration indication



8 b Modbus reset indication



NOTE

Press and hold the tact switch until both LEDs on the PCB blink twice and hold it until both LEDs blink again three times. If the tact switch is released before both LEDs blink again three times, the sensor will have carried out a calibration procedure instead of Modbus registers reset procedure.

Communication holding registers reset procedure:

1. Put the jumper onto pins 1 and 2 of the P4 connector for more than 20 s while the device is powered (see Fig. 9).

Fig. 9 Modbus holding register reset jumper



1
2
3
4
5

2. Modbus communication holding registers from 1 to 3 will be reset to the default values.
3. Remove the jumper.

ATTENTION

Correct reading of air velocity is possible only if it is enabled by holding register 64 (Pitot air velocity) and a transmitter is connected to the appropriate Pitot tube connection set (PSET-PTX-200).

Differential pressure, volume flow and air velocity mode indications:

The display is enabled via writing "1" in holding register 91 (Measurement readout). Writing "0" will disable the display.

When the display is enabled, its mode depends on the value in holding register 61 (Operating mode). There are three display modes activated via writing the relevant figure in holding register 61 - see the table below:

Measurement readout enabled	
Value of holding register 61:	Display mode:
1	Differential pressure
2	Volume flow rate
3	Air velocity

1. Differential pressure display mode:

- 1.1 The LED display indicates the differential pressure level with a resolution of 1 Pa. See **Fig. 10** below. However, since the unit can display up to 4 digits, the values shown are from 0 to 9999, i.e. if the measured differential pressure = 10.000 Pa, the device displays 9999. However, the 3SModbus software always indicates the actual value.

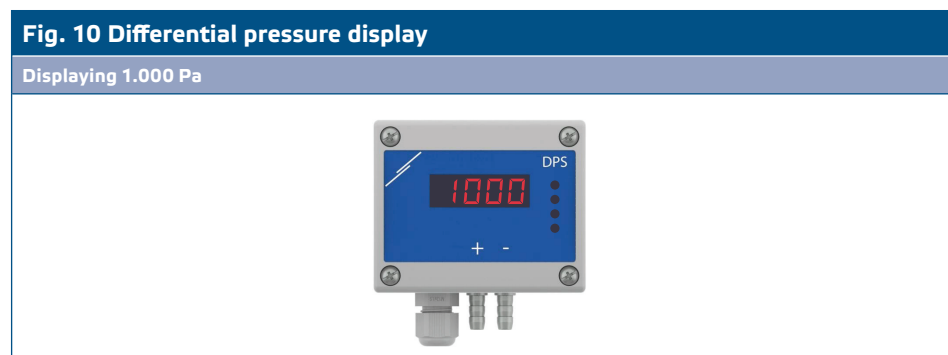

- 1.2 Out of range indication:
 - ▶ The display shows "Lo" every 3 seconds in case the measured differential pressure is lower than the minimum limit of the control range (see **Fig. 11 a**).
 - ▶ In case the measured differential pressure is higher than the control range maximum limit, the display shows 'HI' every 3 seconds (see **Fig. 11 b**).

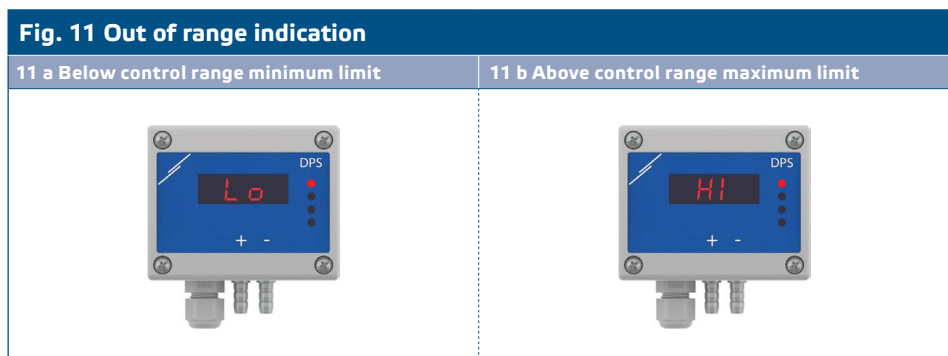

2. Air volume flow display mode:

- 2.1 Air volume flow rate within the range 0–9999 m³/h is displayed with a resolution of 1 m³/h. An example of displaying 100 m³/h is given in **Fig. 13 a** below.
- 2.2 Air volume flow rate above 10.000 m³/h is displayed divided by 1.000. An example of displaying 10.000 m³/h is given in **Fig. 13 b** below.

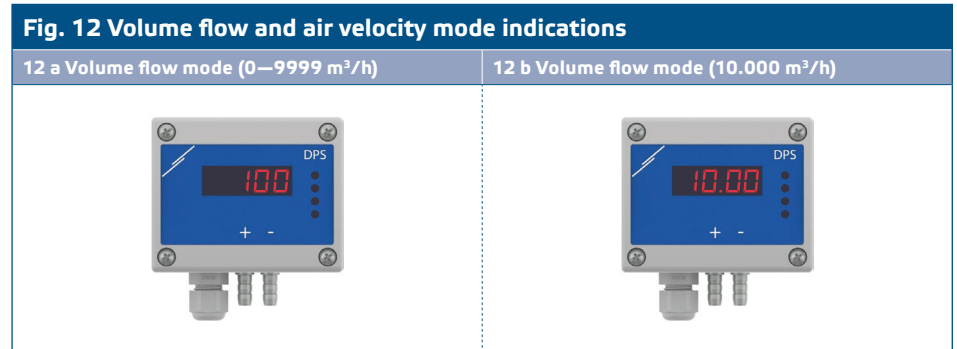

3. Air velocity display mode:

- 3.1 Air velocity is displayed with a resolution of 0,1 m/s. An example of displaying 1,0 m/s is given in **Fig. 13** below.



NOTE

Correct reading of air velocity is possible only if it is enabled by holding register 64 (Pitot air velocity) and a transmitter is connected to the appropriate Pitot tube connection set (PSET-PTX-200).

4. Sensor element failure indication:

In case of failure of sensor element or loss of communication with it, an 'Err' message is displayed and the red LED4 blinks. See **Fig. 14**.



NOTE

Sensor failure condition is displayed only if the display is not in OFF mode (enabled and disabled via holding register 91).

LED indications - LED display disabled (See Fig. 15):

- 1. When the green LED1 is on, the power supply is adequate and Modbus RTU communication is active.
- 2. When the green LED2 is on, the measured value (pressure, volume or air velocity) is between the minimum and maximum alert range.
- 3. When the yellow LED3 is on, the measured value (pressure, volume or air velocity) is below the minimum alert range or above the maximum alert range.

- When the red LED4 is on, the measured value (pressure, volume or air velocity) is below the minimum measurement range or above the maximum.

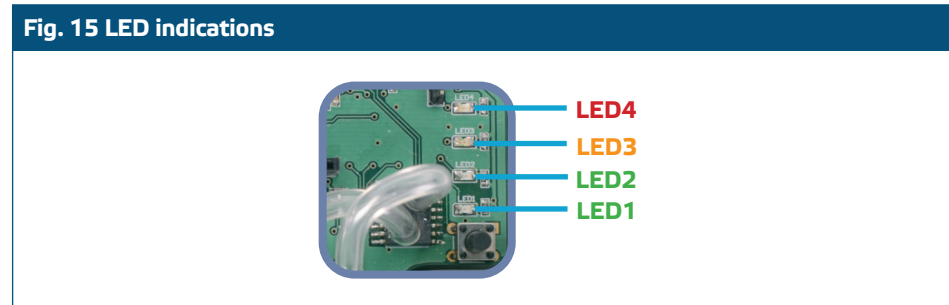

NOTE

Green LED intensity can be adjusted between 0 and 100 % with a step of 10 % according to the value set in Holding register 95.

Kp and Ti tune:

To optimise the functionality of this controller, its behavior and reaction times must correspond to your application. Optimisation can be done by adjusting the Kp (proportional gain) and Ti (integration time) parameters. The auto-tune algorithm automatically calculates the optimal Kp and Ti values for your application. The auto-tune function can be started via Modbus Holding Register 59. If you have extensive knowledge of PI control, you can change Kp and Ti parameters by writing in Modbus Holding Registers 57 and 58. .

VERIFICATION OF THE INSTALLATION INSTRUCTIONS

Continuous green LED1 indication as shown in **Fig.16 Power / Modbus communication indication** means the unit is supplied. If LED1 is not on, check the connections again.

Blinking green LED1 indication as shown in **Fig. 16 Power / Modbus communication indication** means the unit has detected a Modbus network. If LED1 does not blink, check the connections again.

NOTE

For more information, click here to refer to the product datasheet - Settings.



ATTENTION

The status of the LEDs can be checked only when the unit is energised. Take the relevant safety measures!

TRANSPORT AND STORAGE

Avoid shocks and extreme conditions; stock in original packing.

WARRANTY AND RESTRICTIONS

Two years from the delivery date against defects in manufacturing. Any modifications or alterations to the product after the date of publication relieve the manufacturer of any responsibilities. The manufacturer bears no responsibility for any misprints or mistakes in this data.

MAINTENANCE

In normal conditions this product is maintenance-free. If soiled, clean with a dry or damp cloth. In case of heavy pollution, clean with a non-aggressive product. In these circumstances the unit should be disconnected from the supply. Pay attention that no fluids enter the unit. Only reconnect it to the supply when it is completely dry.