

# DCMFX-2R | INTELLIGENT CO<sub>2</sub> DUCT SENSOR

## Mounting and operating instructions

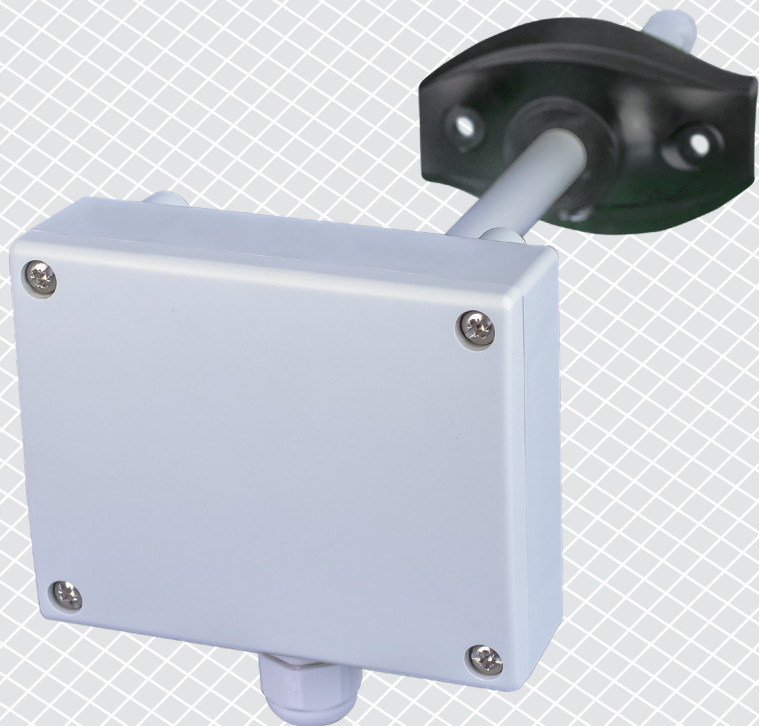

# Table of contents

<b>SAFETY AND PRECAUTIONS</b>	<b>3</b>
<b>PRODUCT DESCRIPTION</b>	<b>4</b>
<b>ARTICLE CODE</b>	<b>4</b>
<b>INTENDED AREA OF USE</b>	<b>4</b>
<b>TECHNICAL DATA</b>	<b>4</b>
<b>STANDARDS</b>	<b>4</b>
<b>OPERATIONAL DIAGRAMS</b>	<b>5</b>
<b>WIRING AND CONNECTIONS</b>	<b>5</b>
<b>MOUNTING &amp; OPERATING INSTRUCTIONS IN STEPS</b>	<b>6</b>
<b>OPERATING INSTRUCTIONS</b>	<b>9</b>
<b>VERIFICATION OF INSTALLATION</b>	<b>9</b>
<b>TRANSPORT AND STORAGE</b>	<b>9</b>
<b>WARRANTY AND RESTRICTIONS</b>	<b>9</b>
<b>MAINTENANCE</b>	<b>9</b>

## SAFETY AND PRECAUTIONS

---



Read all the information, the datasheet, Modbus map, mounting and operating instructions and study the wiring and connection diagram before working with the product. For personal and equipment safety, and for optimum product performance, make sure you entirely understand the contents before installing, using or maintaining this product.



For safety and licensing (CE) reasons, unauthorised conversion and /or modifications of the product are inadmissible.



The product should not be exposed to abnormal conditions, such as extreme temperatures, direct sunlight or vibrations. Long-term exposure to chemical vapours in high concentration can affect the product performance. Make sure the work environment is as dry as possible; avoid condensation.



All installations shall comply with local health and safety regulations and local electrical standards and approved codes. This product can only be installed by an engineer or a technician who has expert knowledge of the product and safety precautions.



Avoid contacts with energised electrical parts. Always disconnect the power supply before connecting, servicing or repairing the product.



Always verify that you apply appropriate power supply to the product and use appropriate wire size and characteristics. Make sure that all the screws and nuts are well tightened and fuses (if any) are fitted well.



Recycling of equipment and packaging should be taken into consideration and these should be disposed of in accordance with local and national legislation / regulations.



In case there are any questions that are not answered, please contact your technical support or consult a professional.

## PRODUCT DESCRIPTION

The DCMFX-2R series are intelligent duct sensors featuring adjustable temperature, relative humidity and CO<sub>2</sub> ranges. The used algorithm controls a single analogue / modulating output based on the measured T, rH and CO<sub>2</sub> values, which can be used to directly control an EC fan, an AC fan speed controller or an actuator powered damper. All parameters are accessible via Modbus RTU.

## ARTICLE CODE

Article code	Supply	I <sub>max</sub>
DCMFG-2R	18–34 VDC	110 mA
	15–24 VAC ±10%	120 mA
DCMFF-2R	18–34 VDC	110 mA

## INTENDED AREA OF USE

- Demand controlled ventilation based on temperature, relative humidity and CO<sub>2</sub>
- Suitable for mounting in air ducts

## TECHNICAL DATA

- Spring contact terminal block
- Analogue / modulating output type:
  - ▶ 0–10 VDC mode: R<sub>L</sub> ≥ 50 kΩ
  - ▶ 0–20 mA mode: R<sub>L</sub> ≤ 500 Ω
  - ▶ PWM (open-collector type) mode: PWM Frequency: 1 kHz, R<sub>L</sub> ≥ 50 kΩ; PWM voltage level 3,3 VDC or 12 VDC
- Selectable temperature range: -30–70 °C
- Selectable relative humidity range: 0–100 %
- Selectable CO<sub>2</sub> range: 0–2.000 ppm
- Modbus RTU communication
- Accuracy: ±0,4 °C (range 0–50 °C); ±3 % rH (range 0–95 % rH);
- Replaceable CO<sub>2</sub> sensor element
- Minimum airflow velocity required: 1 m/s
- Enclosure and probe material:
  - ▶ ASA, grey (RAL9002)
- Protection standard: enclosure: IP54, probe: IP20
- Typical range of use:
  - ▶ Temperature: -30–70 °C
  - ▶ Rel. humidity: 0–100 % rH, (non-condensing)
  - ▶ CO<sub>2</sub>: 400–2.000 ppm
- Storage temperature: -30°C - 70°C

## STANDARDS

- Low Voltage Directive 2014/35/EC CE
  - ▶ EN 60529:1991 Degrees of protection provided by enclosures (IP Code) Amendment AC:1993 to EN 60529
  - ▶ EN 60730-1:2011 Automatic electrical controls for household and similar use - Part 1: General requirements
- EMC directive 2014/30/EU:
  - ▶ EN 60730-1:2011 Automatic electrical controls for household and similar use - Part 1: General requirements
  - ▶ EN 61000-6-1:2007 Electromagnetic compatibility (EMC) - Part 6-1: Generic standards - Immunity for residential, commercial and light-industrial environments

- ▶ EN 61000-6-3:2007 Electromagnetic compatibility (EMC) - Part 6-3: Generic standards - Emission standard for residential, commercial and light-industrial environments Amendments A1:2011 and AC:2012 to EN 61000-6-3
- ▶ EN 61326-1:2013 Electrical equipment for measurement, control and laboratory use - EMC requirements - Part 1: General requirements
- ▶ EN 61326-2-3:2013 Electrical equipment for measurement, control and laboratory use - EMC requirements - Part 2-3: Particular requirements. Test configuration, operational conditions and performance criteria for transducers with integrated or remote signal conditioning
- RoHS Directive 2011/65/EC

## OPERATIONAL DIAGRAMS

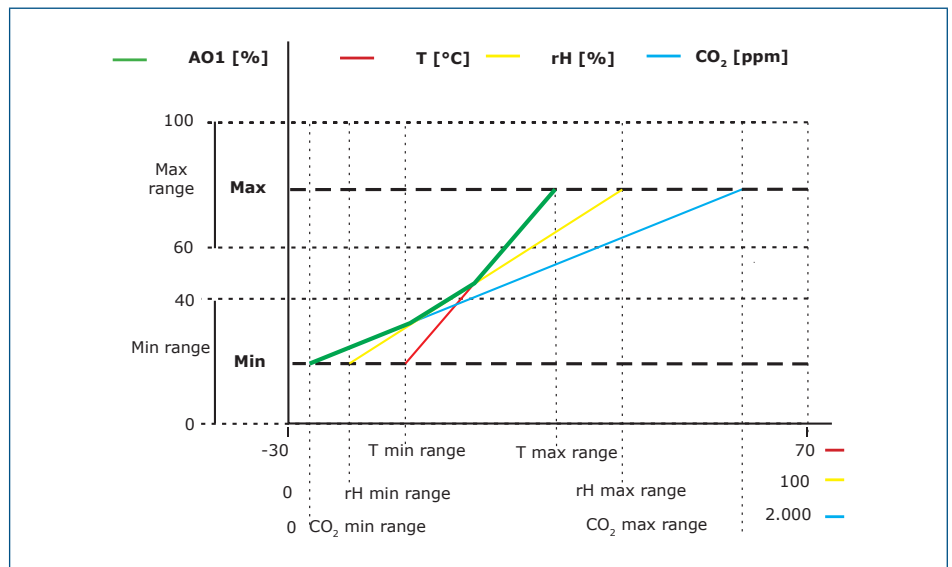

### NOTE

The output changes automatically depending on the highest of the T, rH or CO<sub>2</sub> values, i.e. the highest of the three output values controls the output signal. See the green line in the operational diagram above. One or multiple sensors can be deactivated. E.g. it is also possible to control the output based on the measured CO<sub>2</sub> values only.

## WIRING AND CONNECTIONS

Article type	DCMFF-2R	DCMFG-2R
VIN	18–34 VDC	18–34 VDC
GND	Ground	Common ground
A	Modbus RTU (RS485), signal A	
/B	Modbus RTU (RS485), signal /B	
AO1	Analogue / modulating output (0–10 VDC / 0–20 mA / PWM)	
GND	Ground AO	Common ground
Connections	Spring contact terminal blocks, cable cross section: 1,5 mm <sup>2</sup>	

## ⚠ ATTENTION

The -F version of the product is not suited for 3-wire connection. It has separate grounds for power supply and analogue output. Connecting both grounds together might result in incorrect measurements. Minimum 4 wires are required to connect -F type sensors.

The -G version is intended for 3-wire connection and features a 'common ground'. This means that the ground of the analogue output is internally connected with the ground of the power supply. For this reason, -G and -F types cannot be used together on the same network. Never connect the common ground of -G type articles to other devices powered by a DC voltage. Doing so might cause permanent damage to the connected devices.

## MOUNTING & OPERATING INSTRUCTIONS IN STEPS

Before you start mounting the unit read carefully **"Safety and Precautions"**.

## 📝 NOTE

The compounds released from plastics may influence the sensor readings. Please allow several days for the sensor to stabilize before you obtain the accurate values.

### Follow these steps:

1. When preparing to mount the unit, bear in mind that the probe opening must be positioned in the centre of the duct. Always use the flange to install the sensor on round ducts. It is possible to install the sensor without the flange on rectangular ducts (if necessary), see **Fig. 1** and **Fig. 2** below.

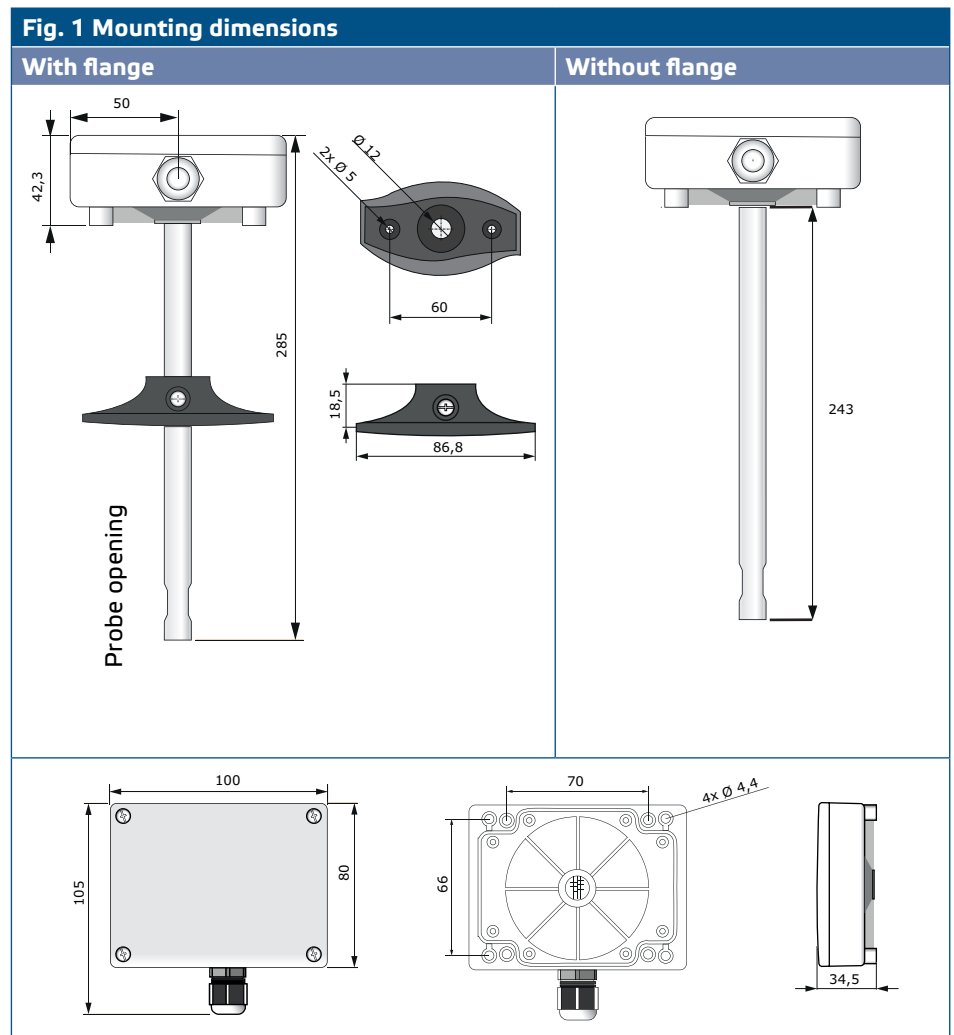

**Fig. 2 Mounting position**

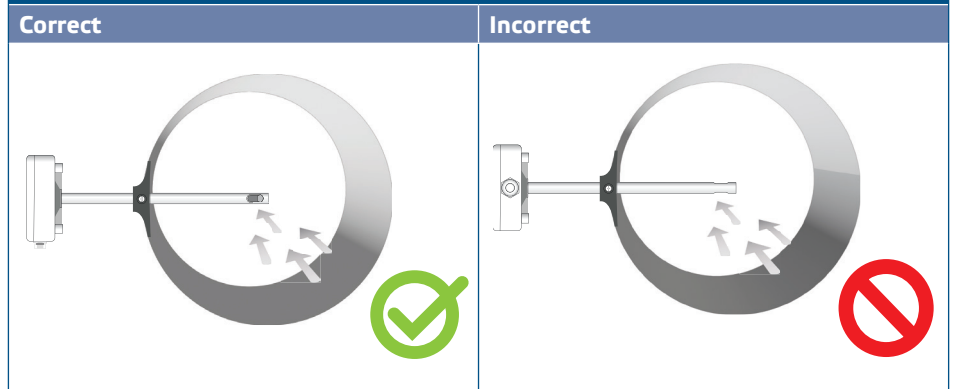

2. Having selected the appropriate mounting location, proceed with the following steps:

- 2.1 Drill an airtight Ø 13 mm hole into the duct.
- 2.2 Fix the flange onto the duct outer surface using the self-drilling screws delivered with the unit. If you do not intend to use the flange, insert the probe and fix the enclosure onto the duct. Mind the airflow direction (see Fig. 2 and Fig. 3).

**Fig. 3 Mounting requirements**

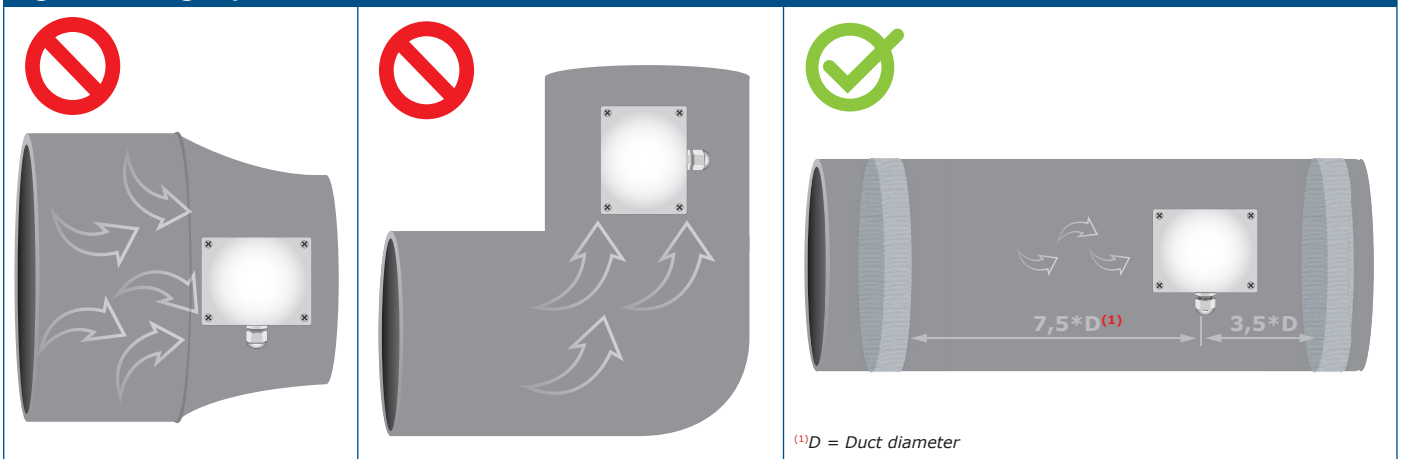

**ATTENTION**

*Installation requirements: The unit must not be installed in turbulent air zones. Ensure sufficiently long settling zones upstream and downstream of the tapping point. A settling zone consists of a straight section of pipe or duct with no obstructions. Avoid installation near filters, cooling coils, fans, etc. The sensor will achieve the optimal result when the measurement is taken at least 7,5 duct diameters downstream and at least 3,5 duct diameters upstream from any turns or flow obstructions.*

**ATTENTION**

*Installation of the unit near high EMI-emitting devices may lead to faulty measurements. Use shielded wiring in areas with high EMI.*

**ATTENTION**

*Keep at least 15 cm distance between the sensor lines and the 230 VAC power lines.*

- 2.3 Install the probe at the desired depth and; in case you use the flange, fix it via the plastic white screw in the flexible flange.
- 2.4 Unscrew the cover of the unit to remove it and insert the connecting cables through the cable gland of the unit.
- 2.5 Do the wiring according to the wiring diagram (see Fig. 4) adhering to the information from section "Wiring and connections".

**Fig. 4 Wiring and connections**

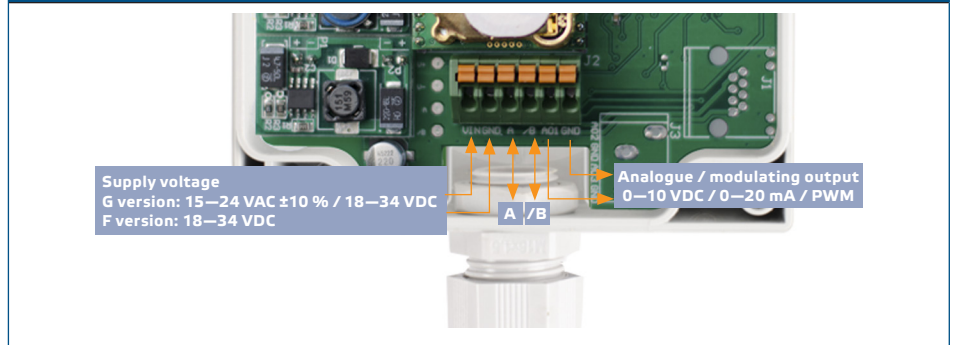

**ATTENTION**

*Do not exceed the maximum power supply rating! Measure before installation! Unregulated 24 VAC supply units provide higher nominal output voltage and activate the integrated fuse protection.*

3. Close the enclosure and fix the cover. Tighten the cable gland to retain the IP rating of the enclosure.
4. Switch on the power supply.
5. Customise the factory settings to the desired ones via the 3SModbus software or Sensistant (if necessary). For the default factory settings, see the *Modbus register map of the product*.

**NOTE**

*For the complete Modbus register data, see the Modbus Register Map of the product, which is a separate document attached to the article code on the website and contains the registers list. Products with earlier firmware versions may not be compatible with this list.*

**Optional settings**

To assure correct communication, the NBT needs to be activated in only two devices on the Modbus RTU network. If necessary, enable the NBT resistor via 3SModbus or Sensistant (*Holding register 9*).

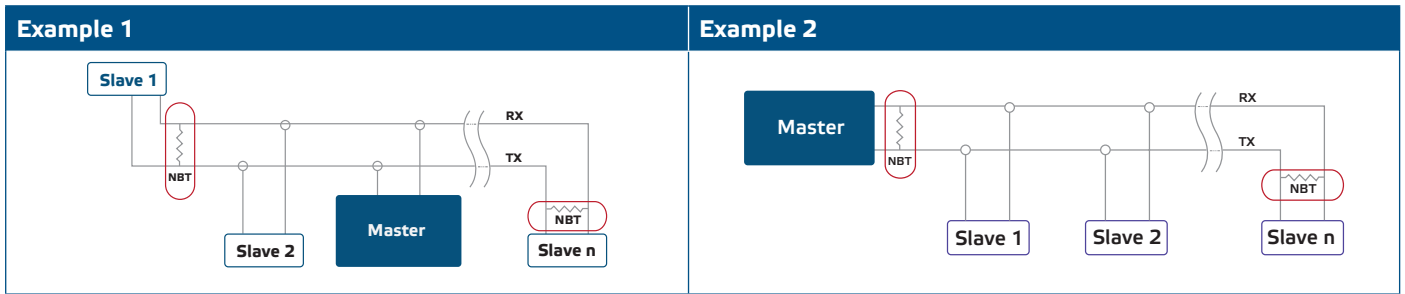

**NOTE**

*On a Modbus RTU network, two bus terminators (NBTs) need to be activated.*

**CAUTION**

*Do not expose to direct sunlight!*



## OPERATING INSTRUCTIONS

---

### Calibration procedure:

Sensor calibration is not necessary. All sensor elements are calibrated and tested in our factory.

In the unlikely event of CO<sub>2</sub> sensor element failure, this component can be replaced.

### Firmware update

New functionalities and bug fixes are made available via a firmware update. In case your device does not have the latest firmware installed, it can be updated. SenteraWeb is the easiest way to update the firmware of the unit. In case you do not have an internet gateway available, the firmware can be updated via the 3SM boot application (part of the Sentera 3SMcenter software suite).



### NOTE

*Make sure the power supply does not get interrupted during "bootload" procedure, otherwise you risk losing unsaved data.*

## VERIFICATION OF INSTALLATION

---

If your unit does not function as expected, please check the connections.

## TRANSPORT AND STORAGE

---

Avoid shocks and extreme conditions; stock in original packing.

## WARRANTY AND RESTRICTIONS

---

Two years from the delivery date against defects in manufacturing. Any modifications or alterations to the product after the date of publication relieve the manufacturer of any responsibilities. The manufacturer bears no responsibility for any misprints or mistakes in this data.

## MAINTENANCE

---

In normal conditions this product is maintenance-free. If soiled, clean with a dry or damp cloth. In case of heavy pollution, clean with a non-aggressive product. In these circumstances the unit should be disconnected from the supply. Pay attention that no fluids enter the unit. Only reconnect it to the supply when it is completely dry.