

ALFC8 | FLUSH OR SURFACE MOUNT MODBUS RTU ALARM UNIT

Mounting and operating instructions



Table of contents

SAFETY AND PRECAUTIONS	3
PRODUCT DESCRIPTION	4
ARTICLE CODES	4
INTENDED AREA OF USE	4
TECHNICAL DATA	4
STANDARDS	4
OPERATIONAL DIAGRAM	5
WIRING AND CONNECTIONS	5
MOUNTING INSTRUCTIONS IN STEPS	6
VERIFICATION OF INSTALLATION INSTRUCTIONS	7
OPERATING INSTRUCTIONS	7
TRANSPORT AND STORAGE	8
WARRANTY AND RESTRICTIONS	8
MAINTENANCE	8

SAFETY AND PRECAUTIONS



Read all the information, the datasheet, mounting and operating instructions and study the wiring and connection diagram before working with the product. For personal and equipment safety, and for optimum product performance, make sure you entirely understand the contents before installing, using, or maintaining this product.



For safety and licensing (CE) reasons, unauthorised conversion and /or modifications of the product are inadmissible.



The product should not be exposed to abnormal conditions, such as: extreme temperatures, direct sunlight or vibrations. Long-term exposure to chemical vapours in high concentration can affect the product performance. Make sure the work environment is as dry as possible; avoid condensation.



All installations shall comply with local health and safety regulations and local electrical standards and approved codes. This product can only be installed by an engineer or a technician who has expert knowledge of the product and safety precautions.



Avoid contacts with energised electrical parts. Always disconnect the power supply before connecting, servicing or repairing the product.



Always verify that you apply appropriate power supply to the product and use appropriate wire size and characteristics. Make sure that all the screws and nuts are well tightened and fuses (if any) are fitted well.



Recycling of equipment and packaging should be taken into consideration and these should be disposed of in accordance with local and national legislation / regulations.



In case there are any questions that are not answered, please contact your technical support or consult a professional.

PRODUCT DESCRIPTION

ALFC8 series are universal programmable alarm units. They can indicate the status of a ventilation system or HVAC installation. The status is indicated via the green, yellow and red LED. It is controlled via Modbus RTU communication. They can be used for inset or surface mounting and have a wide supply voltage range of 85 - 264 VAC / 50 - 60 Hz.

ARTICLE CODES

Code	Supply	Maximum power consumption
ALFC8	85 – 264 VAC / 50 – 60 Hz	3 mA

INTENDED AREA OF USE

- Status indication of a ventilation system via the LED indicators.
- Any Modbus RTU digital network that needs visual signalisation.











TECHNICAL DATA

- Power supply: 85 – 264 VAC / 50 – 60 Hz
- Maximum power consumption: 3 mA
- Protection class: IP 30 (EN 60529)
- Operating ambient conditions:
 - ▶ Temperature: 0–50 °C
 - ▶ Rel. humidity: 5–90% rH (non-condensing)
 - ▶ Storage temperature: -10–60 °C



STANDARDS

- Low Voltage Directive 2014/35/EU CE
 - ▶ EN 60529:1991 Degrees of protection provided by enclosures (IP Code) Amendment AC:1993 to EN 60529
 - ▶ EN 62080:2009 Sound signalling devices for household and similar purposes
- EMC Directive 2014/30/EU:
 - ▶ EN 61000-6-1:2007 Electromagnetic compatibility (EMC) - Part 6-1: Generic standards - Immunity for residential, commercial and light industrial environments
 - ▶ EN 61000-6-3:2007 Electromagnetic compatibility (EMC) - Part 6-3: Generic standards - Emission standard for residential, commercial and light-industrial environments Amendments A1:2011 and AC:2012 to EN 61000-6-3
- RoHS Directive 2011/65/EU

OPERATIONAL DIAGRAM

Operational diagram - LED indications			
			
Action	Operating description	LED indication	Buzzer indication
During the first second	Start-up		
Write value 0 in Modbus HR11 (0 is the default value)	OK		
Write value 1 in Modbus HR11	Warning		
Write value 2 in Modbus HR11	Alarm		
Write value 3 in Modbus HR11	Custom mode (according to HR12-14)		

WIRING AND CONNECTIONS

Article type	ALFC8	
L, N	85 – 264 VAC ± 10 % / 50 – 60 Hz	
A	Modbus RTU (RS485), signal A	
/B	Modbus RTU (RS485), signal /B	
Connections	Spring contact terminal blocks, cable cross section: 0,75 - 2,5 mm ²	
P1 header		Put a jumper between pin 1 and pin 2 for 10 seconds to reset the Modbus communication parameters to their default values (slave address 1, baud rate 19200 Bps, parity even)
		Put a jumper between pin 3 and pin 4 and restart the supply voltage to enter bootloader mode

MOUNTING INSTRUCTIONS IN STEPS

Before you start mounting the unit, carefully read section **Safety and Precautions**. Choose a smooth surface for installation (a wall, panel, etc.) and follow these steps:

Flush mounting

1. Remove the cover of the enclosure.
2. Connect the supply cables, A and /B cables to the terminal blocks, according to the section **Wiring and connections** and the diagram **Fig. 1 "Wiring and connections"**.

Fig. 1 Wiring and connections

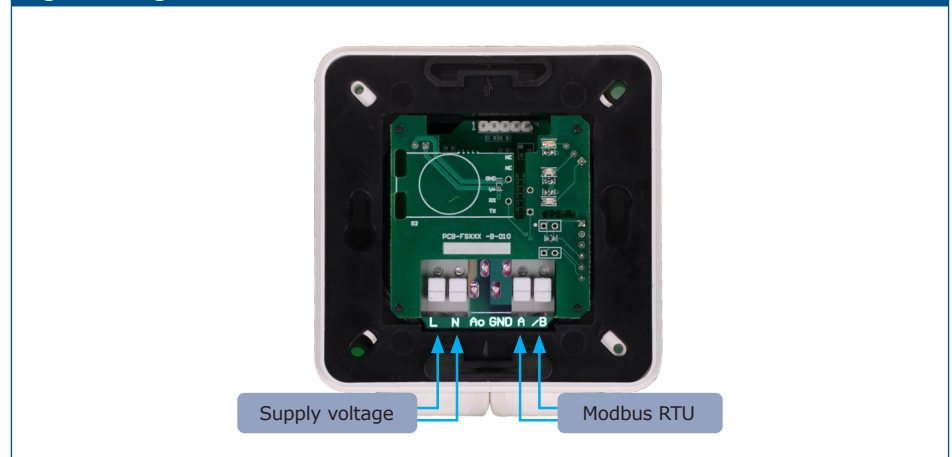

NOTE

Mount the unit so that the terminal block and connections are at the lower side.

3. Fix the inner box with 4 screws.
4. Mount the cover and secure it with the provided screws according to **Fig. 2 "Mounting dimensions - flush mounting"**.

Fig. 2 Mounting dimensions - flush mounting

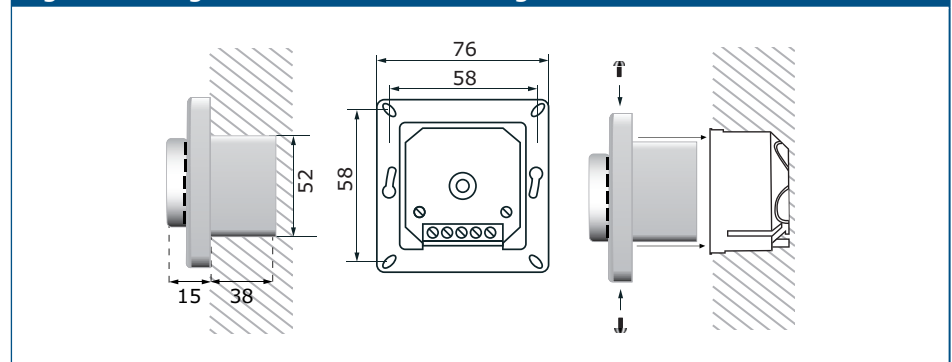

5. Switch ON the supply voltage.
6. Connect unit to Modbus master and adjust settings via Modbus communication.



ATTENTION

High voltages are present, avoid touching it while it is operating!

For surface mounting

1. Remove the cover of the enclosure.
2. Remove the inner box from the surface mounting box.
3. Mount the external enclosure onto the surface by means of screws and dowels adhering to the mounting dimensions shown in **Fig. 3** *Mounting dimensions - surface mounting*.

Fig. 3 Mounting dimensions - surface mounting

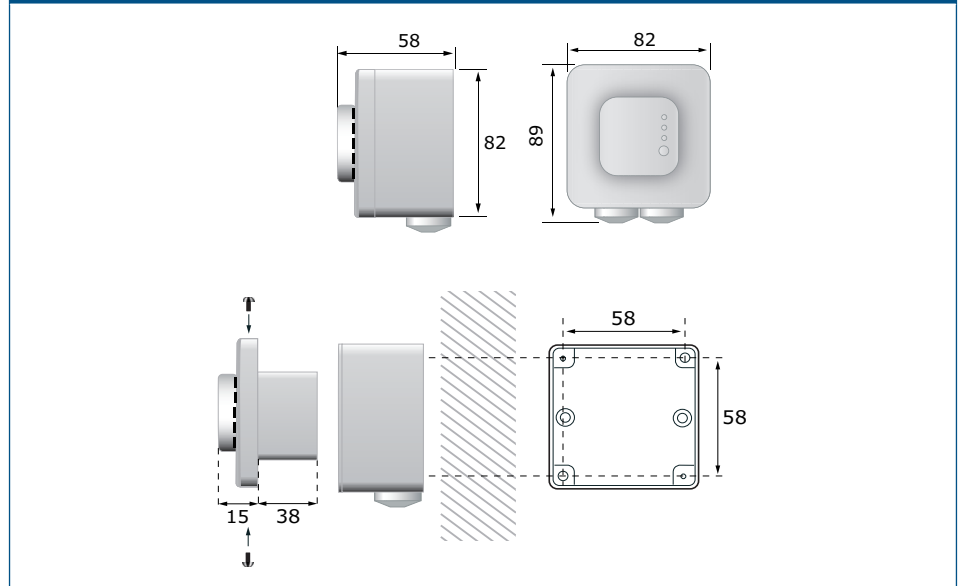

4. Insert the cables through the grommets.
5. Connect the supply cables, A and /B cables to the terminals blocks, according to the section **Wiring and connections** and the diagram **Fig. 1** *“Wiring and connections”*.
6. Insert again the inner box to the surface mounting box and fix it to the surface mounting box with 2 screws.
7. Mount the cover and secure it with the provided screws.
8. Switch ON the supply voltage.
9. Connect unit to Modbus master and adjust settings via Modbus communication.



ATTENTION

High voltages are present, avoid touching it while it is operating!

VERIFICATION OF INSTALLATION INSTRUCTIONS

After switching on the power supply, all three LEDs light up for a second. Afterwards, only the green LED lights up. If this is not the case, check the connections.

OPERATING INSTRUCTIONS

The ALFC8 series are operated via Modbus RTU. To monitor and configure its settings, you can either download the free 3SModbus software from Sentera's website or use the Sensistant tool.



NOTE

For detailed information and settings, refer to the product Modbus register map, which is attached to the article code on our website.

Bootloader

Firmware could be updated using the embedded bootloader via the Modbus RTU communication. The unit enters boot mode after resetting the supply voltage when a jumper is present between pin 3 and pin 4 on the P1 header or if a master device (Sensistant or 3SModbus software with PC) sends such command to the unit (see **Fig. 5**).

Fig. 5 P1 header

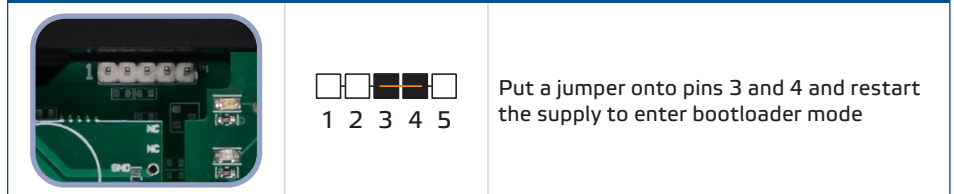

TRANSPORT AND STORAGE

Avoid shocks and extreme conditions; stock in original packing.

WARRANTY AND RESTRICTIONS

Two years from the delivery date against defects in manufacturing. Any modifications or alterations to the product after the date of publication relieve the manufacturer of any responsibilities. The manufacturer bears no responsibility for any misprints or mistakes in this data.

MAINTENANCE

In normal conditions this product is maintenance-free. If soiled, clean with a dry or damp cloth. In case of heavy pollution, clean with a non-aggressive product. In these circumstances the unit should be disconnected from the supply. Pay attention that no fluids enter the unit. Only reconnect it to the supply when it is completely dry.