

STRA1

230 VAC transformer controller with TK and start / stop



The STRA1 series of transformer fan speed controllers regulate the rotational speed of single-phase voltage controllable motors by varying the output voltage. They are equipped with an auto-transformer and control the speed manually in five steps. They feature TK monitoring for thermal motor protection, dry contact input for remote start / stop and a 230 VAC alarm output. The used technology provides a regulated output voltage with a perfect sinusoidal shape. The controllers up to 7,5 A are available in plastic enclosure, while the models above 7,5 A are available in a metal enclosure.

Key features

- Wide power range: 1,5 A–20 A
- 5-step rotary switch for manual control plus off-position
- TK monitoring for thermal motor protection
- Auto restart after power failure
- 230 VAC alarm output
- LED status indication
- 2 dry contact inputs for remote ON / OFF switching

Technical specifications

Supply voltage	230 VAC / 50–60 Hz	
Maximum load	1,5 A–20 A, depending on the version	
Unregulated output	230 VAC / 2 A	
Enclosure	plastic (R-ABS, UL94-V0, grey RAL 7035) or sheet steel (RAL 7035, polyester powder coating), depending on the product version	
Protection standard	IP54 (according to EN 60529)	
Ambient conditions	Temperature	-20–35 °C
	Rel. humidity	5–95 % rH (non-condensing)









Article codes

Article code*	Rated max. current, [A]	Fuse [A]
STRA1-15L22	1,5	(5*20 mm) T-2,5 A-H
STRA1-25L22	2,5	(5*20 mm) T-4,0 A-H
STRA1-35L22	3,5	(5*20 mm) T-5,0 A-H
STRA1-50L22	5,0	(5*20 mm) T-8,0 A-H
STRA1-75L22	7,5	(5*20 mm) T-12,5 A-H
STRA1100L22	10,0	(6*32 mm) T-16,0 A-H
STRA1130L22	13,0	(6*32 mm) T-20,0 A-H
STRA1160L20	16,0	(6*32 mm) T-25,0 A-H
STRA1200L20	20,0	(6*32 mm) T-25,0 A-H

*The last 3 characters represent the voltage series. See table "Voltage series".

Voltage series

Knob position	0	-	1	2	3	4	5
Wires		-					
Regulated output [VAC]							
L20 version**	0	80*	100	120	140	170	230
L22 version**	0	80*	110	140	170	190	230
Unregulated output [VAC]							
All voltage series, L1	0	230	230	230	230	230	230

* Available but not connected.

** If more than 5 output voltages are available, it is possible to adjust the 5 steps by changing the internal wiring.

Area of use

- Fan speed control of voltage controllable motors (pumps and fans) in ventilation systems
- For indoor use only

Wiring and connections

Pe	Earth terminals
L	Power supply, line (230 VAC / 50–60 Hz)
N	Power supply and unregulated output, neutral
L1	Unregulated output, line
N	Regulated output to motor, neutral
M / U	Regulated output to motor, line
CC	Input - normally closed contact for remote ON / OFF switching
CC	
OC	Input - normally open contact for remote ON / OFF switching
OC	
TK	Input - TK monitoring for thermal motor protection
TK	
N	Alarm output (230 VAC / 1 A)
AL	

Standards

- Low Voltage Directive 2014/35/EC
- EMC Directive 2014/30/EC: EN 61326
- WEEE Directive 2012/19/EC
- RoHS Directive 2011/65/EC



STRA1

230 VAC transformer controller with TK and start / stop



Legend

STRA1-15L22, STRA1-25L22, STRA1-35L22, STRA1-50L22, STRA1-75L22

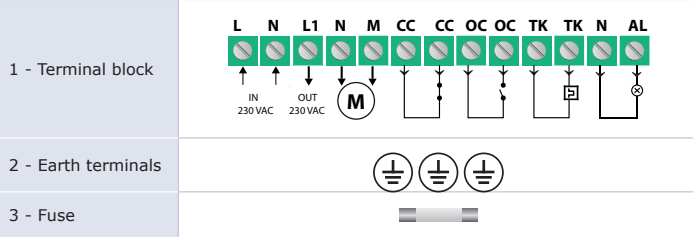
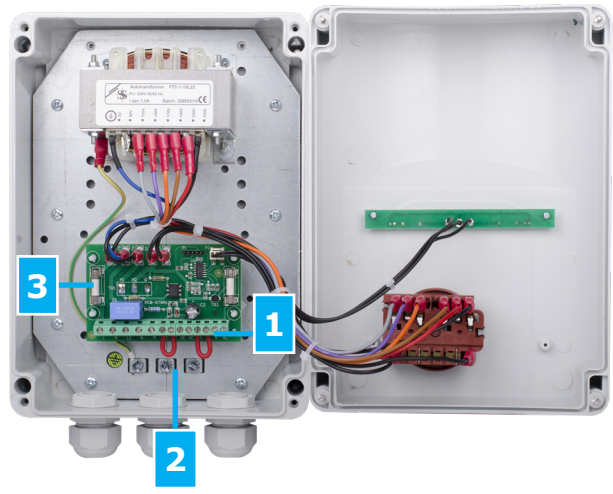

Legend

STRA1100L22, STRA1130L22, STRA1160L20, STRA1200L20

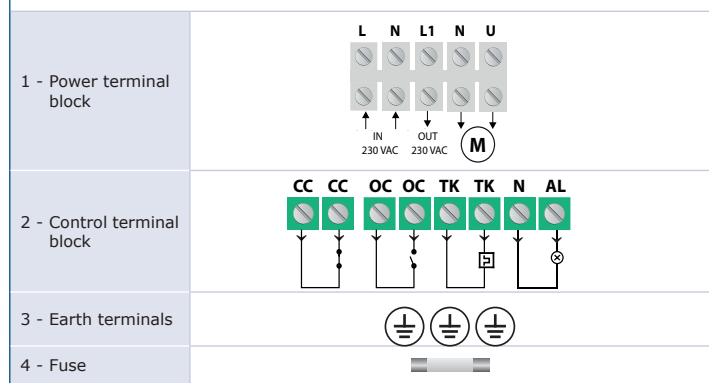
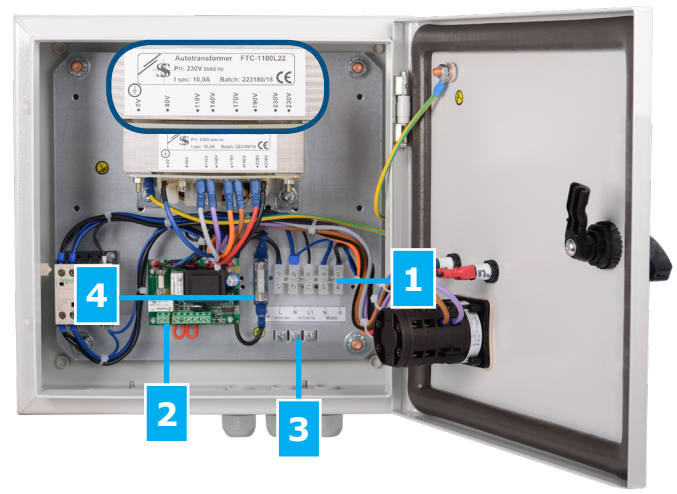

STRA1

230 VAC transformer controller with TK and start / stop



Operational diagram - L20

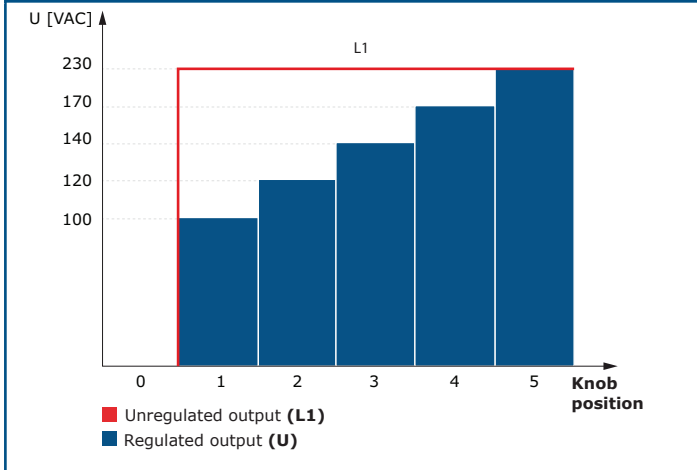

Operational diagram - L22

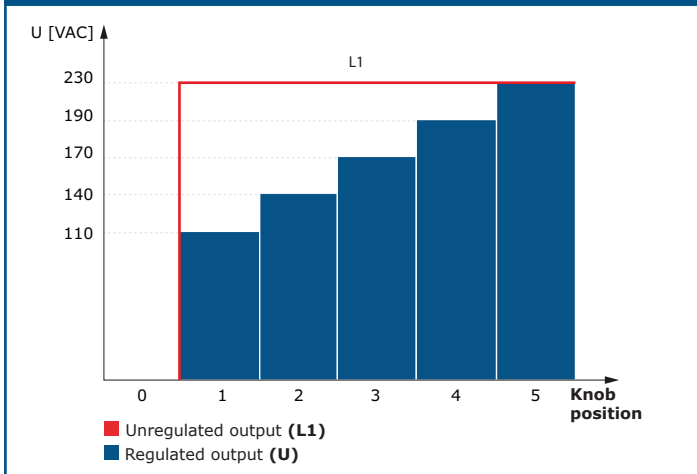

Fixing and dimensions

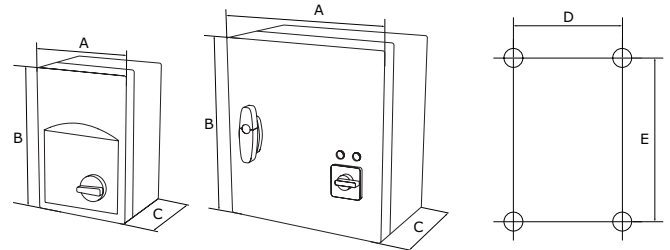

Article code	A [mm]	B [mm]	C [mm]	D [mm]	E [mm]	Enclosure
STRA1-15L22	170	255	140	155	194	plastic (R-ABS, UL94-V0, grey RAL 7035)
STRA1-25L22	170	255	140	155	194	
STRA1-35L22	170	255	140	155	194	
STRA1-50L22	170	255	140	155	194	
STRA1-75L22	200	305	155	183	236	sheet steel (RAL7035, polyester powder coating)
STRA1100L22	300	325	185	255	255	
STRA1130L22	300	325	185	255	255	
STRA1160L20	300	425	235	255	355	
STRA1200L20	300	430	235	255	355	

Packaging

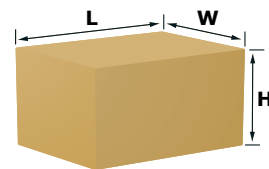

Article code	Packaging	Length [mm]	Width [mm]	Height [mm]	Net weight [kg]	Gross weight [kg]
STRA1-15L22	Unit (1 pc.)	270	180	150	3,2	3,5
STRA1-25L22	Unit (1 pc.)	270	180	150	3,7	4,0
STRA1-35L22	Unit (1 pc.)	270	180	150	4,6	4,9
STRA1-50L22	Unit (1 pc.)	270	180	150	5,6	5,9
STRA1-75L22	Unit (1 pc.)	325	210	155	8,0	8,7
STRA1100L22	Unit (1 pc.)	340	310	200	14,3	14,6
STRA1130L22	Unit (1 pc.)	340	310	200	16,6	17,0
STRA1160L20	Unit (1 pc.)	440	310	250	20,0	20,5
STRA1200L20	Unit (1 pc.)	440	310	250	24,3	24,8