



# SDP-E0US-XT

## Potentiometer with min & max settings

These potentiometers can control equipment that need a variable control signal. The supply voltage is between 5 VDC and 24 VDC. The output is adjusted continuously variable from minimum to maximum or from maximum to minimum via a rotary knob. There is a version without OFF-switch and a version with OFF-switch at the leftmost position. The potentiometer is suitable for both inset (IP44) and surface mounting (IP54).

### Key features

- Variable control of the output signal between minimum and maximum or vice versa
- Minimum and maximum output adjustable by two trimmers
- Analogue / modulating output type selectable via jumper
- Versions available with or without OFF-switch at the leftmost position
- A splash waterproof enclosure
- Inset or surface mounting

### Technical specifications

Supply voltage (Us)	5–24 VDC	
Selectable analogue / modulating output types	0–100% Us mode	min. load 50 kΩ (RL ≥ 50 kΩ)
	0–20 mA mode	max. load 500 Ω (RL ≤ 500 Ω)
	PWM mode	PWM frequency: 1 kHz, min. load 50 kΩ (RL ≥ 50 kΩ) PWM voltage level: 3,3 VDC or 12 VDC
Output	Depends on the position of both trimmers: minimum to maximum or maximum to minimum	
Minimum output value	0 - 100% adjustable by trimmer	
Maximum output value	0 - 100% adjustable by trimmer	
Consumption	19 mA	
Protection standard	IP44 / IP54 (according to EN 60529)	
Ambient conditions	Temperature	0–50 °C
	Rel. humidity	< 95 % rH (non-condensing)



### Wiring and connections

Us	Supply voltage (5–24 VDC)
GND	Supply voltage, ground
Ao	Output signal (0 - 100% Us, 0-20 mA, 0-100% PWM)
GND	Output signal, ground
Connections	Spring contact terminal block, stranded wires 1,0–1,5 mm <sup>2</sup> or wires with cable shoe 0,75–1,0 mm <sup>2</sup> , length 7 mm

### Area of use

- A variety of applications where a variable control signal is required

### Article codes

	Supply	Output	OFF position
SDP-E0US-AT	5–24 VDC	Min - max or max - min	yes
SDP-E0US-BT			no

### Standards

- Low Voltage Directive 2014/35/EU
  - EN 60529:1991 Degrees of protection provided by enclosures (IP Code) Amendment AC:1993 to EN 60529
  - EN 60730-1:2011 Automatic electrical controls for household and similar use - Part 1: General requirements
- EMC directive 2014/30/EU
  - EN 61000-6-2:2005 Electromagnetic compatibility (EMC) - Part 6-2: Generic standards - Immunity for industrial environments Amendment AC:2005 to EN 61000-6-2
  - EN 61000-6-3:2007 Electromagnetic compatibility (EMC) - Part 6-3: Generic standards - Emission standard for residential, commercial and light-industrial environments Amendments A1:2011 and AC:2012 to EN 61000-6-3
  - EN 61000-3-2:2014 Electromagnetic compatibility (EMC) - Part 3-2: Limits - Limits for harmonic current emissions (equipment input current ≤ 16 A per phase)
- WEEE Directive 2012/19/EU
- RoHS Directive 2011/65/EU

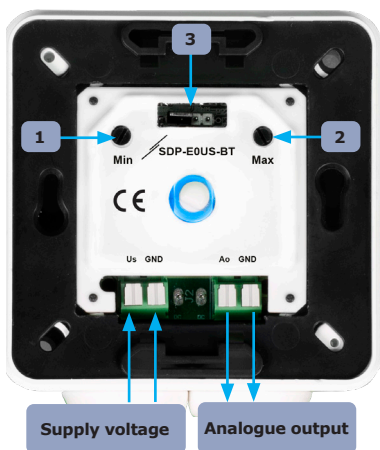

### Settings

1 - Min adjustment trimmer	There is always 20% minimum control range between the values determined by the trimmers.	0 - 80% Us
2 - Max adjustment trimmer		20 - 100% Us
3 - Header for analogue/ modulating output type selection (voltage/current/PWM)		

# SDP-E0US-XT

Potentiometer with min & max settings



## Operational diagram

SDP-E0US-BT

Trimmers: Min < Max

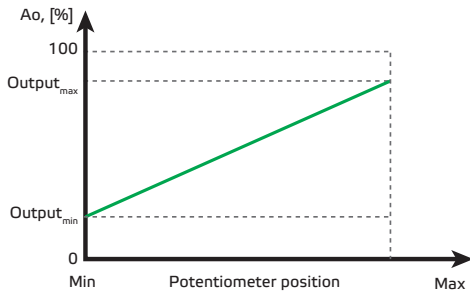

Trimmers: Min > Max

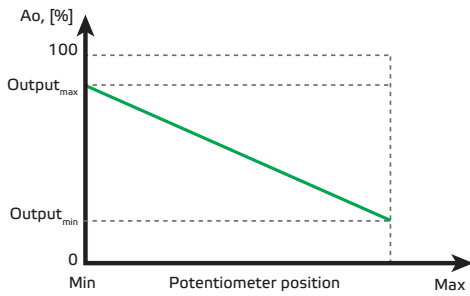

SDP-E0US-AT

Trimmers: Min < Max

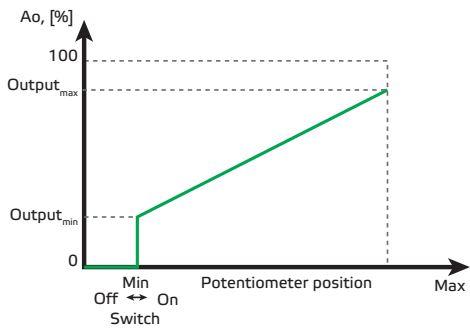

Trimmers Min > Max

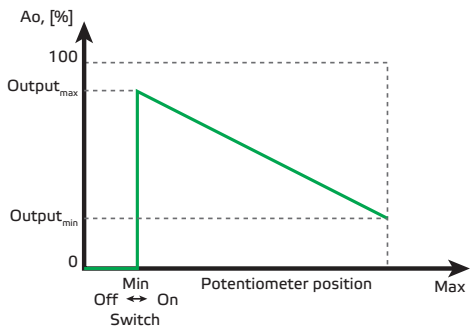

**Note:** By default, the output signal goes from minimum to maximum by turning the rotary knob clockwise. When minimum value is set higher than maximum value, the output signal goes from maximum to minimum by turning the rotary knob. There is always 20% minimum control range between the values determined by the trimmers. The Min trimmer value is taken as a basis. If both trimmers are set to their minimum the actual control of the output will be between 0% and 20%. If both trimmers are set to their maximum the actual control of the output will be between 80% and 100%.

## Fixing and dimensions

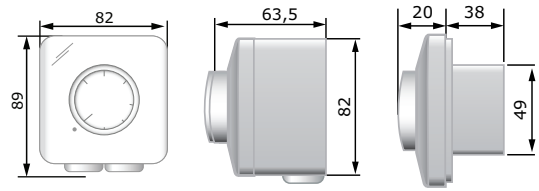

### Surface mounting

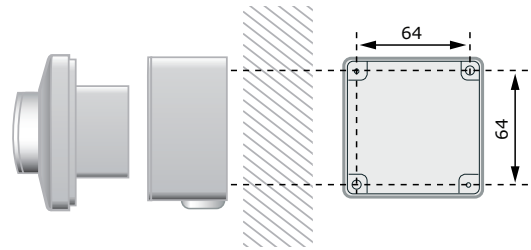

### Inset mounting

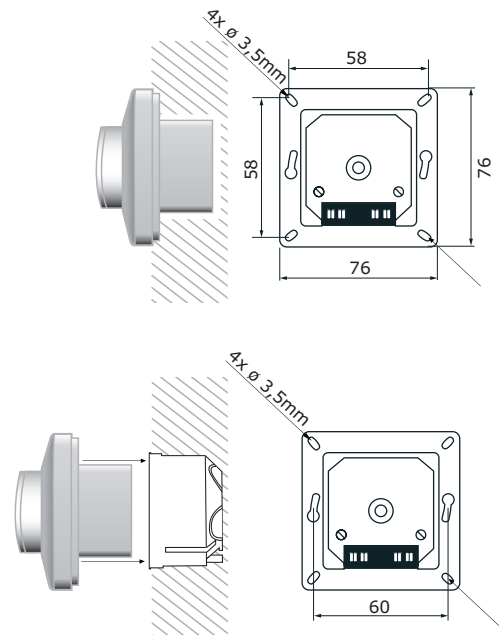

# SDP-E0US-XT

Potentiometer with min & max settings



## Packaging

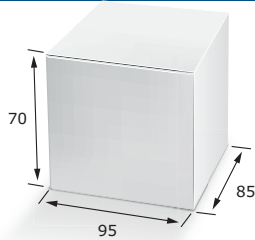

Article	Packaging	Length [mm]	Width [mm]	Height [mm]	Net weight	Gross weight
SDP-E0US-XT	Unit (1 pc.)	95	85	70	0,14 kg	0,17 kg
	Carton (10 pcs.)	492	182	84	1,49 kg	1,85 kg
	Box (60 pcs.)	590	380	280	8,94 kg	12,09 kg